



WHYTE
PERFORMANCE BY DESIGN

2013

WHYTE 2013



2 0 1 3





W H Y T E
P E R F O R M A N C E B Y D E S I G N

RESEARCH AND DEVELOPMENT	PAGES 5-6
WHYTE GEOMETRY	PAGES 7-8
MATERIALS	PAGES 9-10
RACING	PAGES 11-12
FULL SUSPENSION	PAGES 13-14
QUAD LINK II AND QUAD LINK 4	PAGES 15-16
WHYTE 146 TRAIL SUSPENSION	PAGES 17-22
WHYTE T-129 29ER TRAIL SUSPENSION	PAGES 23-26
WHYTE 19 DROPOUT/ GETTA GRIP	PAGES 27-28
WHYTE 900 SERIES TRAIL HARDTAILS	PAGES 29-34
WHYTE M-109 XC/MARATHON 29ER SUSPENSION	PAGES 35-38
WHYTE CARBON HARDTAILS	PAGES 39-46
PERFORMANCE XC HARDTAILS	PAGES 47-56
C7 - ALL TERRAIN SERIES	PAGES 57-64
CROSS SERIES	PAGES 65-70
R7 - FAST URBAN SERIES	PAGES 71-78
PARTS AND ACCESSORIES	PAGES 79-80
GEOMETRY SPECIFICATIONS	PAGES 81-84
SPECIFICATIONS	PAGES 85-94





DESIGNED IN THE UK AND PROVEN ON THE UK'S TOUGHEST TRAILS

Since 1999 Whyte bikes has delivered insistent innovation and cutting edge development, earning bike test awards and rave reviews on an annual basis. Something we're very proud of here at Whyte and the reason you'll never find us standing still.

Pushing the accepted performance limits is our constant goal and having a small and streamlined design team makes us fast on our feet and uniquely responsive to evolving rider demands and new technological opportunities. It means we build the bikes we all want to ride, not the ones accountants and marketing departments would tell us to.

So while our new 2013 line is the biggest ever, we've lost none of that crucial critical focus. Our bikes still handle better, last longer and cope with the UK's uniquely challenging riding demands more easily than any others. It's just that now, even more riders like you - and like us - can find their perfect bike in our range.

W H Y T E

P E R F O R M A N C E B Y D E S I G N



RESEARCH AND DEVELOPMENT

PERFORMANCE BY DESIGN

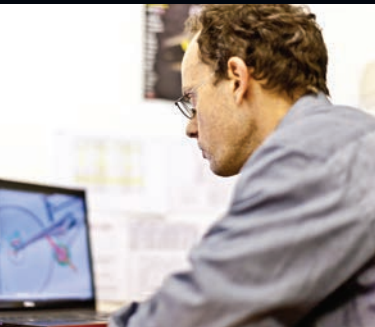

Our R&D address might be in the Cotswolds, but our real test facilities are city streets and mountain trails all over the world.

We work out multi piece carbon lay ups through riding countless laps of Welsh trail centres but have them verified by our race team as far away as the dry riverbeds of Botswana. Our geometry is fractionally exact because we know it makes us faster and gives us more control, not because we've taken an average of what others have done. We confidently put a lifetime warranty on our suspension bearings, because we grind them through the same grit and grime you have to for thousands of hours a year. A CAD machine might make the final rendering, but that big lever on our unique seat clamp is there because we got sick of trying to shut a normal one with frozen fingers. We know the addition of Crud Catcher mounts to our mountain bike frames is a significant one for all of us, because it means our eyes sting less after our lunchtime ride and our tea isn't washing grit off our teeth.

We could go on, but you get the idea. Why? We are genuinely a small group of dedicated UK riders, determined to produce the best bikes we can and not afraid to break some rules and set some benchmarks along the way.

WHYTE GEOMETRY

MUCH MORE THAN JUST NUMBERS

More than anything, the frame geometry of a bike defines its personality and determines how it will behave in different situations. And at Whyte, we're more than a little obsessive about it.

More than a decade's evolution on the UK's trails and roads has led us to ours; a perfectly balanced, confidence-inspiring feel that encourages and rewards the rider in equal measure, whatever their level of skill.

For a beginner, that might mean handling that is always stable and predictable, whatever the terrain. For an intermediate it could mean taking a new, more challenging line on a familiar trail - or for an expert, the ability to push harder and faster than ever before.

THE WHYTE DIFFERENCE

Our relaxed head angle and longer front-centre gives increased stability at speed - especially on steeper descents. A wider bar and shorter stem sharpens up the steering response for slow speed precision. We aim for as short a rear-centre as possible as this gives more agility - allowing the rider to pop and boost through the gnarliest trail obstacles.

The Whyte geometry formula is also applied to our unique 29ers with fantastic effect maintaining the agile handling that all our bikes are known for and offering true performance, balance and control especially on steeper technical sections which can really unsettle many rival designs.







WHYTE

CROSS+MARK 28x2.10 80-63 PSI

SRAM

SRAM

SRAM



MATERIALS SELECTED FOR CONSISTENCY AND LONGTERM PERFORMANCE

We make frames from Aluminium and Carbon Fibre as both of these materials have their own specific properties and their own particular ride characteristics.

Whether we are looking to create the super-stiff structure required for a full suspension bike or the lively yet comfortable ride that characterises a top quality alloy hardtail frame, all the materials we use must have one thing in common - they have to be the best available. Only then can we be sure we are achieving the best possible combination of strength and light weight and that the resulting frame will achieve the benchmark performance required by us and our customers.

ALUMINIUM CUSTOM TUBING FOR LIGHT-WEIGHT STRENGTH AND SUPERIOR RIDE FEEL

For our aluminium trail frames, we use perhaps the ultimate refinement of aluminium alloy frame materials - specifically developed for use in hydro-forming and welded frame construction and custom drawn to our specification. Our selection of premium 6061 grades of aluminium allows us to specify tubes of thinner wall section. This translates into thinner tube butting profiles over the entire length of the tubes and means that for the same strength, stiffness and fatigue characteristics we can engineer a lighter chassis.

Whyte hydro-formed aluminium frame designs concentrate on designing the best most efficient shapes for the chassis. Our seatstays and chainstays have extensive shaping and tapering to increase strength and stiffness generating volume where it's needed, providing maximum mud clearance at key areas of the frame, as well as producing a frame that has a clean, elegant overall design profile and offers discernible comfort benefits in use.

WHYTE CARBON TECHNOLOGY TAILORED FOR A PERFECT RIDE

The performance of any carbon fibre component relies on three things - the quality of the raw material, the integrity of the design and the precision of the assembly. That's why at Whyte, we take complete control of the design process and then work closely with the world's best carbon manufacturers to bring our designs to life.

This close working relationship also means we can develop special combinations of filament grades and resin types to give our carbon frames a genuine performance advantage that others can't match, combined with reliable performance you can trust.

Gravity Enduro racer Neil Halcrow - and his Whyte 146 X



WHYTE RACING

PERFORMANCE BY DESIGN - PROVEN IN COMPETITION

Anyone can throw their shirt on the latest shaven legged wonder and win some races. We prefer our athletic ambassadors to be a little more real though. OK, so the speed global racer Luke Smith will come past you is scarcely believable. The relentless hour-after-hour velocity of multiple Enduro, Polaris and Trans Wales winner Steve Heading isn't good for others egos either. Their performance and passion is both an inspiration and an ideal development tool for us though.



These racers all clock up their victories and rack up training miles on proper tough technical trails and courses. They live and thrive in conditions where several seconds gained on a descent repeated thirty times in 24 hours are worth far, far more than a few shaved grams. Where consistently sure-footed traction and rock solid power transfer enable you to clean climbs all the way to the top of a podium as effectively as they do in the Peak District. It's the reason our geometry is radically different from others default XC templates and why we know an extra 20mm of travel can mean an extra 200m gained through every technical singletrack.

In other words we support racing that translates directly to you going further, faster and having more fun every time you ride. The durable and lightweight frames we produce have a relaxed race geometry which enables our athletes to hammer technical trails, sit in for long climbs and sprint with ease. Our bespoke 29er geometry has reset expectations of how well a bigger wheeled bike can handle.

Racers have relied on the traction and immediate power transfer our designs deliver and have the results to prove it. They have powered fire roads, cleaned technical climbs and descended with precision - and remain an invaluable part of our development and testing process.



WHYTE FULL SUSPENSION

146, T-129, M-109

All Mountain, Trail and Marathon suspension.

ELDR 5



We design our bikes to be ridden relentlessly hard and build an appreciation that borders on addiction. To repay your enthusiasm and effort with the tightest, most responsive and rewarding trail and marathon suspension bikes available.

Our UK weatherproof construction means the suspension bearings come with a lifetime warranty and there's enough tyre room to cope with the worst claggy conditions in winter. That means the shocking acceleration, glued traction and exceptional chaos-proof control you'll experience on your first ride is guaranteed on every following ride however foul the conditions are.

Relentlessly reliable, technically tenacious, blisteringly fast - pick any three...

QUAD-LINK II

26" SUSPENSION SYSTEM

QUAD-Link II takes all the simplicity and low weight benefits of a single pivot design to keep the bike totally rideable and reliable in the worst conditions you can throw at it. At the same time it removes all the inevitable compromises with carefully created controllable wheel paths and variable shock leverage ratios to maximise your control and enjoyment.

It drives, grips, sucks up small bumps, handles hits and keeps control better than any single pivot system, yet it copes with mud, lack of maintenance, gruelling grinding paste trails and future shock changes better than any other 26" linkage design.



The pivot bearings and the way they install into the chassis are all specifically designed for maximum lifespan on all our suspension bikes. That's why we can offer an unbeatable lifetime warranty on the pivot bearings of our bikes.

QUAD 4

29ER SUSPENSION SYSTEM

When we set out to design a suspension layout for 29ers we knew it had to be very different - nothing currently available offers our benchmark combination of progressive, contemporary frame geometry with year-round weatherproof reliability, a hereditary Quad-Link suspension feature.

We specified a weatherproof system, as our year-round riding demands it. We also needed to keep the rear of the bike as compact and stiff as possible whilst minimising the distance between the rear wheel and bottom bracket centres - no mean feat on a 29er suspension bike, but one of the fundamentals to Whyte's unique handling elixir.



The resulting suspension package, codenamed Quad 4, provides the perfect balance of suspension and frame geometry - and breaks new ground whilst covering it faster and smoother than you'd believe possible.





W H Y T E 1 4 6 TRAIL SUSPENSION

A genre, redefined.

“One bike - Every trail” is a pretty tough design brief, but it is exactly what we have achieved with the 146. We are setting new standards for Trail riding with unrivalled strength-to-weight and unmatched suspension performance. From your favourite descent to your toughest climb the lightweight and supremely agile full carbon fibre chassis will challenge you to constantly push harder and faster. Climb like an XC bike, descend like a downhill bike, the 146 provides confidence-inspiring, trail-taming geometry and genre-redefining performance that will exceed your expectations every time you ride.

“an outstanding ride-enhancing rule bender the Whyte 146 is an astonishing bike”
What Mountain Bike Magazine 2011.

Designers Notes: 146

“We set out to improve the 146 still further: A re-developed chassis yielding an 11% stiffer torsional construction to complement the latest 34mm Fox Forks. SRAM's revolutionary 1x11 XXI drivetrain combines with a spec that's set-up to give the Trail Rider the ultimate bike. The still avant-garde geometry sets this bike apart when it comes to out and out trail riding.”



146 XI

TYPICAL USAGE: TRAIL

- We use monocoque technology as it allows us to integrate key parts of the frame in one structure, rather than building separate parts and joining them together later. This has real performance benefits. It's the lightest way to produce a frame that is both stiff and strong
- A full carbon tapered headtube gives us fantastic stiffness which delivers very accurate tracking and steering performance in both low and high speed use, for 2013 we have added a tube to link the top tube with the down tube creating even more torsional stiffness
- SRAM new XXI 1 by 11 Groupset really moves the trail bike spec forward, now giving a huge 10-42 tooth spread of gears

PF 30



146 WORKS

TYPICAL USAGE: TRAIL

■ We use monocoque technology as it allows us to integrate key parts of the frame in one structure, rather than building separate parts and joining them together later. This has real performance benefits. It's the lightest way to produce a frame that is both stiff and strong

■ A full carbon tapered headtube gives us fantastic stiffness which delivers very accurate tracking and steering performance in both low and high speed use and for 2013 we have added a tube to link the Top Tube with the Down Tube increasing torsional stiffness. 146mm of rear suspension travel

■ SRAM PF30 bottom bracket improves durability in UK conditions and integrated ISCG05 tabs allow you to easily change your setup to a single chainring with a chain device

PF 30

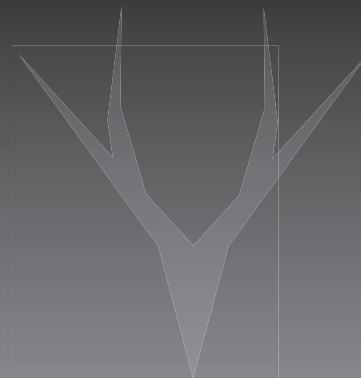

146 S

TYPICAL USAGE: TRAIL

- The 146 S is built around exactly the same ground-breaking full carbon monocoque chassis and swingarm as the Works and XI models. For 2013 it now features the same lightweight finish as the XI model
- Whyte designed suspension systems are engineered to perform smoothly for years to come. To back that up, we provide a lifetime warranty on all the suspension pivot bearings
- The frame has integrated internal routing for the Reverb Stealth dropper seatpost for easy upgrading. 146mm of rear suspension travel

PFC 30



WHYTE
PERFORMANCE BY DESIGN



SUSPENSION: 146 S



W H Y T E T - 1 2 9

29ER TRAIL SUSPENSION

Control the trail.

Born of our acclaimed T-120, this dynamic new 29er trail platform combines high-speed efficiency with the flow and 3D agility of the best contemporary trail bikes, thanks to its unique Whyte geometry. Climb, carve, descend - the T-129 will also hold incredible speed in technical sections that would previously have you grabbing a fist full of brake. Ride it like you stole it - these bikes are guaranteed to put a massive grin on your face, and leave others trailing in your wake.

Designers Notes: T-129

"The same Quad-4 packaging envelope also lets us design a Mid-Travel Trail full suspension 29er with correctly proportioned geometry. Uniquely, we have engineered what no one yet has achieved, a balance and weight distribution of a progressive 26" trail bike, but for the 29er full-suspension age..."

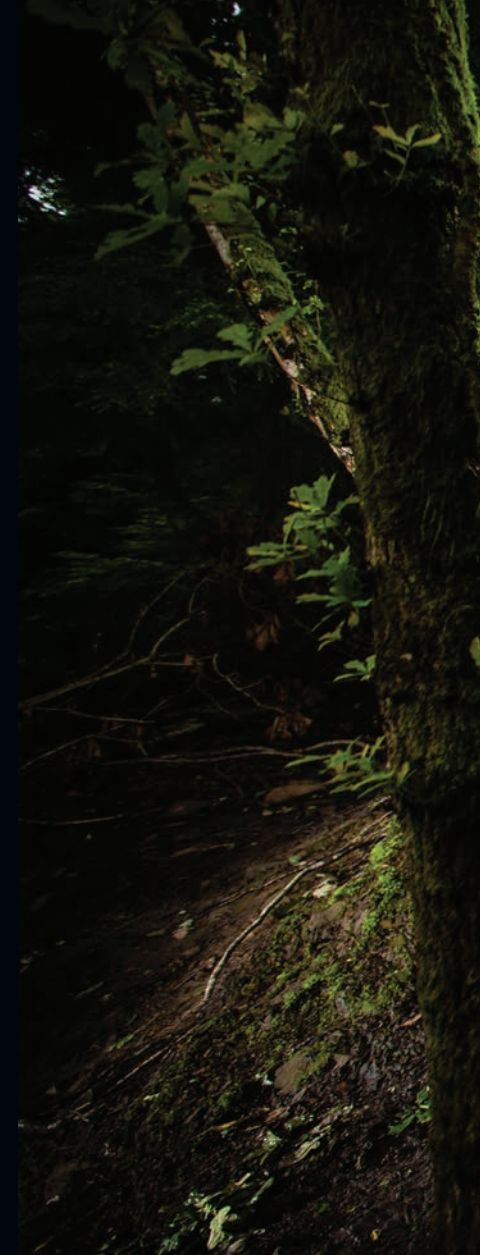



T-129

TYPICAL USAGE: TRAIL



■ Our new Quad 4 suspension layout allows us to apply our contemporary 29er Trail hardtail geometry to the 120mm Suspension Tail Bike category. Short chainstays gives this bike the agility of a 26" wheel bike but with the inertia and terrain "flattening" advantages of a larger 29er wheel

■ Lifetime warranty bearings are used throughout the design, giving this bike exceptional durability in the harshest UK conditions

■ Speed and flow is the name of the game with the T129, keep off the brakes as long as you dare, tip the bike in as hard as you can and try and work out how you have tamed your favourite single track so fast. Welcome to our World!



T-129 S

TYPICAL USAGE: TRAIL



■ Our new Quad 4 suspension layout allows us to apply our contemporary 29er Trail hardtail geometry to the 120mm Suspension Tail Bike category. Short chainstays gives this bike the agility of a 26" wheel bike but with the inertia and terrain "flattening" advantages of a larger 29er wheel

■ Lifetime warranty bearings are used throughout the design, giving this bike exceptional durability in the harshest UK conditions

■ Speed and flow is the name of the game with the T129S, keep off the brakes as long as you dare, tip the bike in as hard as you can and try and work out how you have tamed your favourite single track so fast. Welcome to our World!



WHYTE
PERFORMANCE BY DESIGN



SUSPENSION: T-129 S



WHYTE ADJUSTABLE DROPOUT

AS FEATURED ON THE WHYTE 929 AND 905

As you might expect from Whyte not even something as simple as the rear dropout is left without a magic touch from our designers. Used on the award winning 905, our unique dropout system provides geometry adjustment as well as easy conversion to a single speed setup.

The CNC machined rear dropouts allow a plus or minus 10mm adjustment of the chainstay length from the zero centre position. With the chainstay length increased the bike sits slightly lower giving a more relaxed feel to the ride and providing more stability on steep, technical descents. Shortening the chainstay length raises the bottom bracket height slightly for increased ground clearance, improved climbing and sharper handling in tight, twisty singletrack.

Both dropout plates are engraved with markings to make accurate wheel alignment quick and easy and the stepless adjustment is perfect to accurately tension the chain for a single speed or hub gear set up with no need to adjust the brake caliper.

GETTA GRIP

AS FEATURED ON THE WHYTE 146, T-129, M-109, 929 AND 905

Getta Grip has been developed from scratch to improve the way a seatpost is held in the frame. Traditional clamps need to bend the frame to grip the seat post and often bind after long periods of use, as the frame can no longer "remember" its original shape.



The Patented Getta Grip system takes a whole new approach using a pad that fits through a window in the frame - ideal for UK conditions as there is no open slot to let in mud and water. Because the Getta Grip seat clamp only has to hold the seatpost rather than bend the frame, less force is required to operate it. The clamping force is spread more evenly making it ideal for carbon posts and has been officially approved by Easton for use with all their seatposts.







900 SERIES TRAIL HARDTAILS 26" AND 29ER XC/TRAIL

We still feel sorry for the many people who don't 'get it'. Sorry for those riders whose full suspension bikes can't keep our trail hardtails in sight on descents, let alone singletrack. Sorry for those on race hardtails who've swallowed their tongues keeping pace with it on the climbs but who are now picking themselves out of the bushes on the exit of the first corner.

We'll even extend apologies to the designers who've tried and failed to match our unique hardtail handling elixir. An elusive mix as pitch perfect for blitzing trail centres, ripping up your riding group or vanishing into the wilds for a weekend.

Designers Notes: 929

"A 120mm Trail-Hardtail with a super-strong 29" wheelset, packaged into a geometry that bears very close comparison to our 26" bikes. Needless to say, our slack head, short chain stays and low BB design give the 929 true trail bike balance and handling."

929

TYPICAL USAGE: XC/TRAIL



■ The 929 is an evolution of our ground breaking 29er geometry, built around a Fox 120mm front fork and using very short rear centre, this bike will bring "flow" to your riding, as well as the other advantages of the bigger wheels

■ The 929 brings 1 by 10 to 29ers, this "real world" solution is now available on a production bike.

■ Mud clearance and all weather features have long been associated with our designs and when Whyte set out to design a 29er there was no exception. We have fitted our unique adjustable dropouts, so you can run the chainstays short in the summer and longer in the Winter for more mud clearance



WHYTE
PERFORMANCE BY DESIGN



TRAIL HARDTAIL: 929



905

TYPICAL USAGE: XC/TRAIL

- Using trail geometry developed over 7 years, the 905 offers no-compromise performance and sublime handling
- The frame is constructed from the highest quality 6061 Aluminium Alloy, extruded and manipulated to our exact specification. The rear seat stays are brand new for 2013 giving even more comfort which contributes in a big way to the 905's acclaimed ride characteristics
- For 2013 the 905 frame is fitted with Whyte's Getta Grip seat clamp and our Adjustable Dropout system, which allows the rider to tune the geometry to suit their style or favourite terrain



WHYTE
PERFORMANCE BY DESIGN



TRAIL HARDTAIL: 905





901

TYPICAL USAGE: XC/TRAIL

- Using the same trail geometry developed for the 905, the 901 offers no-compromise performance and sublime handling
- The frame is constructed from 6061 aluminium alloy, extruded and manipulated to our exact specification. Post mount dropouts are new for 2013
- The brand new rear seat stays are precisely shaped and sculpted to help give the 901 excellent ride characteristics and even more comfort







W H Y T E M - 1 0 9

29ER XC/MARATHON SUSPENSION

Just one ride of our early hand built prototype and we knew we were onto something very special with the M-109. Minutes, not seconds carved off our favourite test loops. Incredible control, remarkable momentum, outstanding traction and intoxicating speed. By far, the most accomplished XC bike we have built and a bike that encouraged our test riders to ride further and harder than ever before.

For smooth, all-day, map-shrinking speed combined with year-round weatherproof construction, no other 29er suspension bike comes close.

Designers Notes: M-109

“Quad-4 gives us the opportunity to design an XC race and marathon full suspension 29er with correctly proportioned geometry. Uniquely, we have engineered what no one yet has achieved, genuine progressive 26” geometry for the 29er full-suspension age...”

M-109

TYPICAL USAGE: XC/MARATHON



■ Conceived as the ideal Marathon/Endurance ride, our 100mm travel M-109 bikes are designed for long, high-speed days in the saddle. Our Quad 4 suspension layout creates room for a larger 29" wheel and is built around lifetime bearings for smooth operation today and forever - guaranteed

■ Whyte's 29er XC geometry keeps the back of the bike as short as possible, uniquely combining 26" agility with 29er momentum for speed and control

■ The M-109 combines Whyte's XC-209 custom wheelset and Maxxis' market-leading high air volume Ikon tyres for an exceptional lightweight wheel package - essential for a nimble feel on any 29er

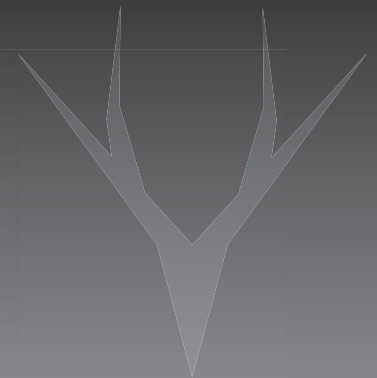

M-109 S

TYPICAL USAGE: XC/MARATHON



■ Conceived as the ideal Marathon/Endurance ride, our 100mm travel M-109 bikes are designed for long, high-speed days in the saddle. Our Quad 4 suspension layout creates room for a larger 29" wheel and is built around lifetime bearings for smooth operation today and forever - guaranteed

■ Lifetime warranty bearings are used throughout the design, giving this bike exceptional durability, in the harshest UK conditions

■ Whyte's own design XC-209C Carbon Wheelset guarantees excellent acceleration and maneuverability



WHYTE
PERFORMANCE BY DESIGN



SUSPENSION: M-109 S





Designers Notes: X-29 Performance Hardtail Series

"We've brought our progressive geometry ideas to these new for 2013 XC 29" hardtails. Aesthetically closely mirroring the design of the Carbon 29C frames, the development of the new X-29 chassis has resulted in a more confidence inspiring 29er geometry for a performance hardtail. Simply put it means a faster and a more fun ride experience."

WHYTE CARBON HARTAILS

CROSS COUNTRY, RACE

Hand Tailored, for a perfect ride.

Precision cut carbon fibre, painstakingly laid up in 3D moulds by master craftsmen. No shortcuts here - it's a complex and challenging process, but the results are truly outstanding. These custom lightweight chassis deliver exceptional torsional stiffness for surgically precise tracking and unflinching power delivery in both 26" and 29" guise.

Whyte's unique trail honed geometry lets you push the pace just as hard on the descents as the climbs too, making this the ultimate high velocity hardtail for racers and endurance athletes.

We've engineered in some comfort too. Combined with our small diameter seat post, the svelte seat-stays provide just enough compliance to help reduce rider fatigue during long days in the saddle.



By mounting the caliper inside the rear stays with our unique dropout, we can feed the brake loads into the chainstay, allowing us to use much less material in the seat stays. This improves comfort and saves weight.



One look at the deep section chainstays tells you that you won't have to live with any energy sapping torsional flex when you're putting down the power.

29ER C TEAM

TYPICAL USAGE: CROSS COUNTRY/RACE 

■ We have taken all our experience in award winning hardtail designs and applied the same winning formula to our 29er's to deliver balance and control

■ Our Unique Whyte Frame Geometry is more sure-footed than a typical light-weight XC Race bike, inspiring confidence on more technical sections

■ Whyte's custom unidirectional high modulus carbon wheels are stiff and light, making the 29-C Team fast off the line and out of corners



WHYTE
PERFORMANCE BY DESIGN



CARBON 29: 29-C TEAM



WHYTE 29 - C CARBON

TYPICAL USAGE: CROSS COUNTRY, RACE

We set out to build our 29ers around the Whyte frame geometry philosophy of UK-proof, year round performance, balance and control - perfectly suited to classic UK XC riding. And our 29ers are unique. We run shorter chain stays coupled to a slightly more relaxed head angle as it allows more length in the front of the bike, greatly improving the feel of the bike and maintaining the agile handling that all our bikes are known for.



Our Carbon Hardtail chassis take a big step forward in both power transfer and comfort terms. One look at the deep section chainstays tells you that you won't have to live with any energy sapping torsional flex when you're putting down the power. And the exquisitely shaped and svelte seat stays help to take the sting out of the trail, taking the edge off the jolts and vibrations that otherwise lead to rider fatigue and discomfort.

29ER CS

TYPICAL USAGE: CROSS COUNTRY/RACE 

- We have taken all our experience in award winning hardtail designs and applied the same winning formula to our 29er's to deliver balance and control
- Our Unique Whyte Frame Geometry is more sure-footed than a typical light-weight XC Race bike, inspiring confidence on more technical sections
- With a Tapered steerer tube and 15mm Maxle Lite front wheel interface and the excellent Easton EA70-XCT UST compatible wheelset this bike will not only get you round your favourite XC loop in a record breaking time, it will also give you the control and balance of the very best of our Whyte trail bikes



WHYTE
PERFORMANCE BY DESIGN



CARBON 29: 29-C S



29ER C

TYPICAL USAGE: CROSS COUNTRY/RACE 

- We have taken all our experience in award winning hardtail designs and applied the same winning formula to our 29er's to deliver balance and control
- Our Unique Whyte Frame Geometry is more sure-footed than a typical light-weight XC Race bike, inspiring confidence on more technical sections
- A lightweight wheelset is essential to 29er performance. Whyte's XC-209 custom wheelset is both light and hand-built for premium quality



20-C TEAM

TYPICAL USAGE: CROSS COUNTRY/RACE

- The 20-C Team bike is specced using the FSA SLK Carbon PressFit 30 crankset combined with XTR brakes, XTR drive train, and the all new Easton EC70 full uni-directional carbon wheels

- This full Monocoque chassis delivers exceptional torsional stiffness for surgically precise tracking and unflinching power delivery

- Our Unique Whyte Frame Geometry is more sure-footed than a typical light-weight XC Race bike, inspiring confidence on more technical sections

- All three models in the 20-C line use the same, high performance frameset



20-C



20-CS



WHYTE
PERFORMANCE BY DESIGN



CARBON 29: 20-C TEAM









PERFORMANCE XC HARDTAILS CROSS COUNTRY, RACE

They look fast, just standing still.

Climb aboard and you'll see the initial feeling of speed is much more than just an illusion. Our unique geometry fuses cross country agility with trail-honed handling, encouraging you to push your limits on the descents as well as the climbs.

The Performance XC Hardtail series offer a perfect introduction to the Whyte brand. Constructed of lightweight butted aluminium with the same geometry to the acclaimed carbon hardtails, all bikes are built for thrashing in tough UK conditions. 100mm forks, 2.2 tyres, wide low-rise bars and short stems create a high octane, trail ready ride that is both responsive and thrilling whether you choose a 26" wheel or 29er variant.

Whether you are riding your local woods, lining up for your 1st race grid or setting the pace with friends at the trail centre this range is going to deliver.

Designers Notes: Performance XC Hardtails

"A new highly developed frameset for 2013, retaining the same design flair and style, but adding a sophisticated aesthetic to match the carbon fibre chassis. Stiffer, lighter and stronger. The same confidence inspiring progressive geometry concept means faster and more fun riding. This is what we mean when we talk about UK inspired ride geometry..."

729

TYPICAL USAGE: CROSS COUNTRY



- The same high quality frameset features on all the X-29 bikes. The custom tubing is drawn to our specification and then profiled, butted and shaped to give what we consider to be the perfect ride feel

- The X-29 geometry is based on the ground breaking 29-C frame. The unique Whyte combination of XC speed, Trail bike handling and all-day comfort bring some thing very special to the 29er movement

- These frames bristle with UK design features, such as extra mud clearance for all-weather usability, forward facing seat slot to keep rear wheel spray out of the frame, continuous outers for improved cable life and crud-catcher mounts on the downtube to keep the grit out of your teeth



WHYTE
PERFORMANCE BY DESIGN



XC HARDTAIL: 729





629

TYPICAL USAGE: CROSS COUNTRY



■ The same high quality frameset features on all the X-29 bikes. The custom tubing is drawn to our specification and then profiled, butted and shaped to give what we consider to be the perfect ride feel

■ The X-29 geometry is based on the ground breaking 29-C frame. The unique Whyte combination of XC speed, Trail bike handling and all-day comfort bring something very special to the 29er movement

■ These frames bristle with UK design features, such as extra mud clearance for all-weather usability, forward facing seat slot to keep rear wheel spray out of the frame, continuous outers for improved cable life and crud-catcher mounts on the downtube to keep the grit out of your teeth



529

TYPICAL USAGE: CROSS COUNTRY

- The same high quality frameset features on all the X-29 bikes. The custom tubing is drawn to our specification and then profiled, butted and shaped to give what we consider to be the perfect ride feel
- The X-29 geometry is based on the ground breaking 29-C frame. The unique Whyte combination of XC speed, Trail bike handling and all-day comfort bring some thing very special to the 29er movement
- These frames bristle with UK design features, such as extra mud clearance for all-weather usability, forward facing seat slot to keep rear wheel spray out of the frame, continuous outers for improved cable life and crud-catcher mounts on the downtube to keep the grit out of your teeth



WHYTE
PERFORMANCE BY DESIGN 

XC HARDTAIL: 529



805

TYPICAL USAGE: CROSS COUNTRY

■ For 2013 there is a brand new high quality frameset which features on all our XC performance hardtails. The custom tubing is drawn to our specification and then profiled, butted and shaped to give what we consider to be the perfect ride feel

■ Our trail-honed geometry is both fast and reassuring, encouraging you to push your limits on the descents as well as the climbs

■ These frames bristle with UK design features, such as extra mud clearance for all-weather usability, forward facing seat slot to keep rear wheel spray out of the frame, continuous outers for improved cable life and crud-catcher mounts on the downtube to keep the grit out of your teeth



WHYTE
PERFORMANCE BY DESIGN



XC HARDTAIL: 805



801

TYPICAL USAGE: CROSS COUNTRY

- For 2013 there is a brand new high quality frameset which features on all our XC performance hardtails. The custom tubing is drawn to our specification and then profiled, butted and shaped to give what we consider to be the perfect ride feel
- These frames bristle with UK design features, such as extra mud clearance for all-weather usability, forward facing seat slot to keep rear wheel spray out of the frame, continuous outers for improved cable life and crud-catcher mounts on the downtube to keep the grit out of your teeth
- Shimano 9 speed drive train, Rockshox XC 28 with Lock-out and Tektro Hydraulic Disc Brakes, coupled to the X-8 triple butted Alloy 6061 frame make for an amazing package



WHYTE
PERFORMANCE BY DESIGN



XC HARDTAIL: 801



802

TYPICAL USAGE: CROSS COUNTRY

- The 802 geometry is designed with a slightly shorter top tube and a little more standover height to offer a better fit for women.

For 2013 there is a brand new high quality frameset which features on all the X-8 bikes. The custom tubing is drawn to our specification and then profiled, butted and shaped to give what we consider to be the perfect ride feel

- These frames bristle with UK design features, such as extra mud clearance for all-weather usability, forward facing seat slot to keep rear wheel spray out of the frame, continuous outers for improved cable life and crud-catcher mounts on the downtube to keep the grit out of your teeth

- Shimano 9 speed drive train, with shorter 170mm cranks and women's anatomic saddle complete the package

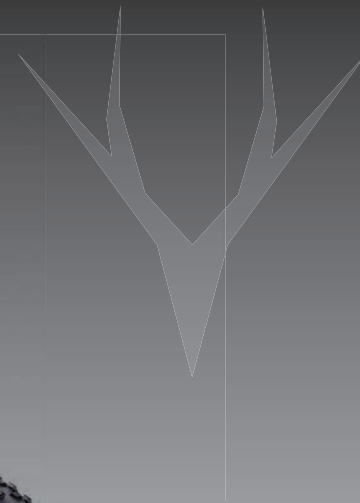





A wooden signpost for 'ALPINE COLLIERY' is visible in the background, with a wooden bench in the foreground. The signpost has a white sign with the text 'ALPINE COLLIERY' and '411' and '82m' below it. The bench is made of dark wood and is partially visible in the foreground. The background is a lush green forest.

ALPINE COLLIERY

C7: ALL TERRAIN SERIES

VERSATILITY WITH COMFORT AND STYLE

Named after some of the UK's most scenic locations, these All Terrain bikes offer versatility with style. It's all about choice - and this category from Whyte simply refuses to be pigeonholed. Whether you are touring the lakes, following a canal network or climbing an Alpine Col the lightweight yet robust range has all your needs covered. The C7 series is also a perfect "Cycle to Work scheme" bike, complete with rack mounts and suspension forks for comfort - or fix on a pannier set and go exploring.

Designers Notes: C7 Series

"This range is where Whyte 29" MTB design concepts clash with the Trekking bike. Resulting in off-road performance and style, mated to functional do-anything chassis and parts spec. Clean frame design with all cables and hoses out of the way, and reliable hydraulic disc brakes on every model."

CONISTON

TYPICAL USAGE: ALL TERRAIN

- When we set out to create a range of bikes that would handle all-terrain use we started with the geometry of the frame. 12 years of off-road experience told us that these bikes first and foremost need to handle sweetly, whether riding along a canal tow path, heading down a woodland trail, or beating the traffic on the way through town

- A custom rear drop out allows us to fit the hydraulic disc brake caliper inside the rear triangle leaving you plenty of room to fit a rack and mudguards if desired

- Full Shimano 10 speed SLX and XT components make the Coniston a class act



WHYTE
PERFORMANCE BY DESIGN



C7: CONISTON



CHILTERN

TYPICAL USAGE: ALL TERRAIN

- When we set out to create a range of bikes that would handle all-terrain use we started with the geometry of the frame. 12 years of off-road experience told us that these bikes first and foremost need to handle sweetly, whether riding along a canal tow path, heading down a woodland trail, or beating the traffic on the way through town
- A custom rear drop out allows us to fit the hydraulic disc brake caliper inside the rear triangle leaving you plenty of room to fit a rack and mudguards if desired
- Full Shimano 10 speed using the SL/XT Trekking groupset for unbeatable performance and reliability



CALEDONIAN

TYPICAL USAGE: ALL TERRAIN

- Our custom built frames are loaded with unique design touches and British weatherproof features - such as the forward facing seat slot that stops water spray from the rear wheel getting into the frame and the continuous outer cables that keep the gear shifting working smoother for longer
- The ride-feel of these bikes is second to none, with a fantastic quality lightweight frame including our unique rear seat stays which really improve the comfort and performance, whatever the terrain
- Full Shimano 9 speed with a SLX Shadow Rear Derailleur and Octalink BB interface for MTB levels of durability



WHYTE
PERFORMANCE BY DESIGN



C7: CALEDONIAN



MALVERN

TYPICAL USAGE: ALL TERRAIN

- Our custom built frames are loaded with unique design touches and British weatherproof features - such as the forward facing seat slot that stops water spray from the rear wheel getting into the frame and the continuous outer cables that keep the gear shifting working smoother for longer
- The ride-feel of these bikes is second to none, with a fantastic quality lightweight frame including our unique rear seat stays which really improve the comfort and performance, whatever the terrain
- Full Shimano 9 Speed group to give years of unrivaled performance and puncture resistant tyres for extra reliability and piece of mind



CALEDONIAN WOMEN'S

TYPICAL USAGE: ALL TERRAIN

- All the same key design features as the men's version, with the added benefit of a partially dropped top tube. This increases standover height, while still keeping enough room inside the frame to comfortably fit a water bottle

- Another benefit of the partially dropped tube is the maintained stiffness of the frame (fully dropped top tube frames are flexy and offer less steering control)

- Full Shimano 9 speed Deore with Octalink BB interface for MTB durability



WHYTE
PERFORMANCE BY DESIGN



ALL TERRAIN: CALEDONIAN WOMEN'S



MALVERN WOMEN'S

TYPICAL USAGE: ALL TERRAIN

- All the same key design features as the men's version, with the added benefit of a partially dropped top tube. This increases standover height, while still keeping enough room inside the frame to comfortably fit a water bottle
- Another benefit of the partially dropped tube is the maintained stiffness of the frame (fully dropped top tube frames are flexy and offer less steering control)
- Full Shimano 9 Speed group to give years of unrivaled performance and puncture resistant tyres for extra reliability and piece of mind







CROSS SERIES

CROSS, ALL TERRAIN, COMMUTE

Mix it up on and off road.

Once upon a time, for the ultimate in versatility and year-round use, you couldn't beat a traditional cross bike.

But now you can. Whyte uses disc brakes, super-tough wheels and our unique Whyte Frame Geometry to create a new breed of high performance multi-role cross-over bikes.

Designed to cope with a gnarly off-road trail a Whyte cross bike is equally at home on a high-speed commute through the urban sprawl, easily handling the curbs, grates and drains that would stop a lesser bike in its tracks, offering speed and lightweight construction combined with off-road resilience.

Designers Notes: CX

"The ultimate Cross-Over bike. Race CX? Winter MTB? Commute? Grand-Touring? Winter Road Training? The Whyte design team build them to cover all the bases. Disc Brakes for no-brainer year-round durability, and our own take on CX Geometry, to really liberate this bike's spectrum of uses. "

SAXON CROSS

TYPICAL USAGE: CX RACE/ALL TERRAIN

- Whyte have applied the Whyte Frame Geometry to the all purpose CX category. The Saxon Cross gives you Whyte's most versatile bike, whether commuting, riding your favorite bridle path or winter training this bike will do it all. Or alternatively go try a CX race this winter, this bike can do it all!
- SRAM Apex and Rival combine to give a great power delivery, Avid provide the stopping power with BB-7's and Whyte have designed a truly great all-round frame
- A straight bladed carbon fork with a tapered steerer tube gives this bike great front end stiffness and steering precision





CHARING CROSS

TYPICAL USAGE: COMMUTE/ALL TERRAIN

- A strong Alloy 6061 frame, with mudguard and rack eyelets combined with deep section R-7 wheels and disk brakes will give years of reliable all-season performance

- Whyte have applied the Whyte Frame Geometry to the all purpose CX category, designed for commuting longer distances, through your favorite park or down the local Sustrans path, this versatile bike will soak up whatever you throw at it

- Shimano Tiagra 10 speed drive train with 34-50 compact gearing will give a great spread of gear ratios whether commuting fully loaded or winter training



WHYTE
PERFORMANCE BY DESIGN



CROSS SERIES: CHARING CROSS



KINGS CROSS

TYPICAL USAGE: COMMUTE/ALL TERRAIN

- Whyte have applied the Whyte Frame Geometry to the all purpose CX category, designed for commuting longer distances, through your favorite park or down the local Sustrans path, this versatile bike will soak up whatever you throw at it
- A strong Alloy 6061 frame, with mudguard and rack eyelets combined with deep section R-7 wheels and disk brakes will give years of reliable all-season performance
- Shimano Sora 9 speed drive train with compact gearing will give a great spread of gear ratios whether commuting fully loaded or winter training







R 7 : F A S T U R B A N S E R I E S

U R B A N , C O M M U T E

The series name certainly gives a clue to our intentions, but by no means tells the full story. Whyte have defined a new category here, combining the best elements of an Urban MTB, the immediate power delivery of a road bike and the design flair of a Single Speed.

Our unique geometry balances precise steering control with stability a perfect combination for life in the fast lane. The frames are mountain-bike tough, to cope with the rigours of the daily commute and super-comfortable so you arrive at work invigorated for the day ahead. Add the uber-clean (and dare we say stylish) look of the Whyte Fast Urban bikes and you won't just be saving time cutting through town, you'll be stealing a few admiring glances along the way.

Designers Notes: R-7 Series

"MTB inspired ride Geometry and compact fit, Road Inspired Speed and components, Fixed inspired style cues: Clean frame design with all cables and hoses out of the way, and zero maintenance hydraulic disc brakes on every model...A British concept for the Great British Commute."

MONTPELLIER

TYPICAL USAGE: URBAN/COMMUTE

- The 2013 Montpellier gets an all-new Carbon RC-7 frame and fork. We have incorporated our "Oversize/Undersize approach from our carbon hardtails to give great power delivery away from the lights, but with class leading comfort

- Based on our high performance mountain bike geometry, the Montpellier bridges the gap between out-right road speed and MTB control, with its long wheelbase and relaxed head angle for high speed stability, and a shorter stem for excellent slow speed maneuverability

- The Montpellier takes advantage of SRAM's all new Via GT groupset, specifically designed for Urban riding with optimised ratios and slightly wider Q factor for a little more heel clearance. Hope Evo hubs finish off this dream urban spec



Designers Notes: RC-7

"Take an R-7 concept, and design and manufacture in carbon. Whyte's own exclusive proprietary carbon moulds mean we retain the R-7's category defining edge: Geometry. MTB inspired Geometry, Road Inspired Speed, Fixie inspired style: Whyte R-7."

STIRLING

TYPICAL USAGE: URBAN/COMMUTE

- Based on our high performance mountain bike geometry, the Stirling has a long wheelbase and relaxed head angle for high speed stability, and a shorter stem for excellent slow speed maneuverability
- A custom rear dropout allows us to mount the rear hydraulic disc brake caliper inside the rear triangle, clearing the way for any rack or mudguards that may be required
- Our shaped, butted and uniquely profiled rear stays give all our Fast Urban bikes a fantastically responsive and comfortable ride, especially when combined with the top quality carbon fibre front fork



WHYTE
PERFORMANCE BY DESIGN



R7 FAST URBAN: STIRLING



CAMBRIDGE

TYPICAL USAGE: URBAN/COMMUTE

■ Based on our high performance mountain bike geometry, all our Fast Urban bikes have a long wheelbase and relaxed head angle for high speed stability, and a shorter stem for excellent slow speed maneuverability

■ A custom rear dropout allows us to mount the rear hydraulic disc brake caliper inside the rear triangle, clearing the way for any rack or mudguards that may be required

■ Our shaped, butted and uniquely profiled rear stays give all our Fast Urban bikes a fantastically responsive and comfortable ride, especially when combined with the top quality carbon fibre front fork



CAMBRIDGE VARSITY
COLOUR OPTION



WHYTE
PERFORMANCE BY DESIGN



R7 FAST URBAN: CAMBRIDGE



PORTOBELLO

TYPICAL USAGE: URBAN/COMMUTE

- Based on our high performance mountain bike geometry, all our Fast Urban bikes have a long wheelbase and relaxed head angle for high speed stability, and a shorter stem for excellent slow speed maneuverability
- A custom rear dropout allows us to mount the rear hydraulic disc brake caliper inside the rear triangle, clearing the way for any rack or mudguards that may be required
- Our shaped, butted and uniquely profiled rear stays give all our Fast Urban bikes a fantastically responsive and comfortable ride



WHYTE
PERFORMANCE BY DESIGN



R7 FAST URBAN: PORTOBELLO





VICTORIA

TYPICAL USAGE: URBAN/COMMUTE

- Based on our high performance mountain bike geometry, the Victoria has a long wheelbase and relaxed head angle for high speed stability, a shorter stem for excellent slow speed manoeuvrability and slightly shorter and lower top tube to fit a women's physique better
- A custom rear dropout allows us to mount the rear hydraulic disc brake caliper inside the rear triangle, clearing the way for any rack or mudguards that may be required
- Our shaped, butted and uniquely profiled rear stays give all our Fast Urban bikes a fantastically responsive and comfortable ride



WHYTE

PARTS AND ACCESSORIES

Upgrade your bike with Whyte Parts and Accessories

Whyte have carefully selected parts and accessories that we are confident will improve your riding experience, offering performance, quality and dare we say it, style. Manufactured by leaders in their field, you can be sure any part that carries the Whyte brand logo has been tried and tested and offers best of breed performance.



Whyte Wheelset

This disk brake specific 700C replacement wheel set comprises front (28H) and rear (32H) wheels built around tough, cnc machined, anodized alloy hubs, using DT competition spokes and tough Whyte R7 series rims. Each pair of Whyte Wheels also comes with a Whyte decal set so you can chose the colour that best suits your bike. To complete the package, we include a set of lockable skewers for added security.

Whyte Carbon Wheels

Lightweight carbon wheels are the most significant upgrade you can make to your 29er with their improved acceleration and manoeuvrability. Ours are CEN certified and manufactured with unidirectional, high modulus carbon with a 1K outer shock-skin for improved impact resistance. Featuring DT Swiss competition triple butted spokes with alloy nipples, they come in either Trail or XC spec

XC Spec - W003

Rear Hub 32 hole, 135mm with XT Skewer

Front Hub 28 hole, 110 X 15mm Maxle or Shimano E-Thru compatible

1515 gm per pair

Trail Spec - W004

Rear Hub 32 hole, 142mm x 12mm Maxle or Shimano E-Thru compatible

Front Hub 28 hole, 110 X 15mm Maxle or Shimano E-Thru compatible

1615 gm per pair

Whyte Dual Density Grip

Whyte's dual density grips offer the best combination of hard wearing construction and comfort in use. Lock-on system for easy installation.

Whyte Dual Density Ergonomic Grip

It's comfort all the way with our Ergonomic grips. Tough yet hard wearing and very easy to install with a built in lock-on system.

Whyte Lock on Gel Grip

This lightweight gel grip is found on all our best trail bikes. Super-slim diameter for better hand wrap, reducing fatigue. Simple to install with a built in lock-on system. File grip waffle pattern for unrivalled control.

Whyte Comfort Saddle

This saddle uses a patented double density design. It combines a resin shell in high stress areas with a flexible Kraton base in pressure point areas for comfort. Double Density design gives this sporty saddle performance and comfort in one package.

Whyte Sports Saddle

Lightweight construction, a really comfortable feel and a contemporary finish. Ergonomic shaping reduces pressure on sensitive areas for increased comfort over longer distances.

Whyte Trail Stem Kit in either 60mm 70mm or 80mm

Forged, CNC machined, wide-section Trail stem. Today's ever-wider trail bars need stiffer stems to cope with the extra leverage without flexing. Ours is light and very strong. For ultimate steering control combine with our Whyte Trail Bar.

Whyte Trail Bar

710 wide, 20mm rise, 5x9 degree sweep. Manufactured from exceptional 2014 alloy and shot peened for added strength, the Whyte Trail bar takes steering control to a new level. For ultimate steering control combine with our Whyte Trail Stem Kit.

Note: All alloy handle bars must be replaced at least every two years or after suffering any impact damage.

Whyte Security Skewers

Lock it or lose it. Protect the wheels you love by replacing your QRs with these security skewers. Unlike many similar products, these skewers use a rare 5 sided key to unlock them.



WHYTE FRAME GEOMETRY

Geometry the angles that define the way a bike interacts with the rider and the trail - is the most important part of any bike's character and performance.

It affects every aspect from that welcoming initial confidence, comfort and control to how hard you push yourself hours into a race or what new technical sections you've mastered months after your first ride. Whether it's that crucial traction balance on the crux move of a killer climb or calmly making a turn millimeters from the edge of potential disaster on a flat out descent, we've designed our bikes to handle superbly in every situation.

Our R&D office uses Autodesk 3D CAD packages to allow us to conceive, develop and perfect potential geometry before we even get on the trail.

Unlike many manufacturers we rework our geometry for each and every bike too.

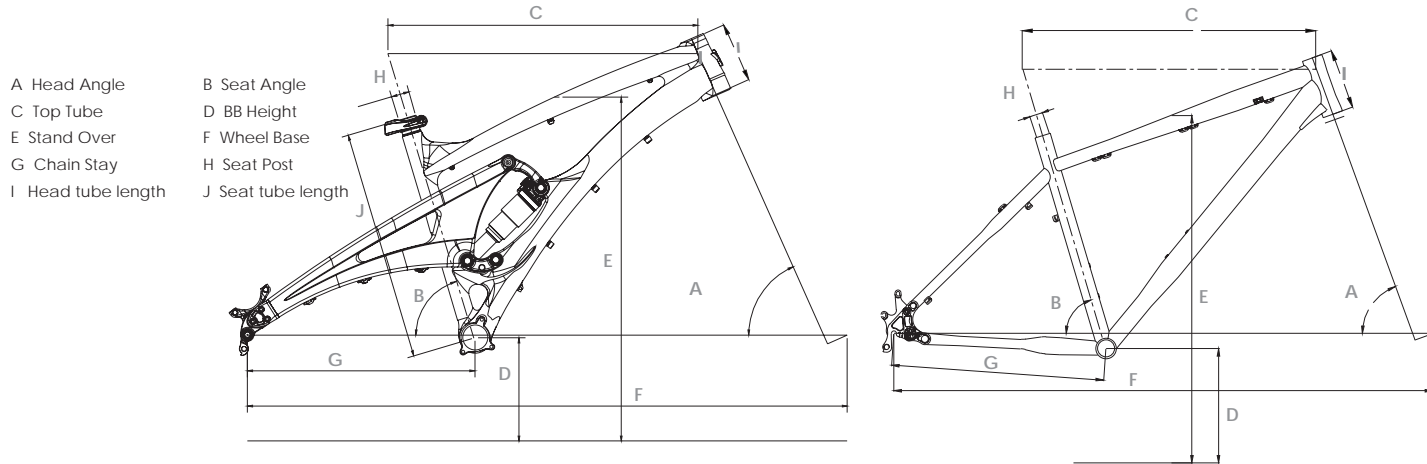

Likely use, likely riders, suspension function, frame attributes it all affects what angles and dimension will create the optimum character. We also break down each individual aspect of a bike's geometry as well as the components we use so we can isolate and precision tune each vital variable. By co-developing suspension and handling geometry in tandem we can ensure that both work together seamlessly in every situation too.

Finally we build a selection of prototypes for our development team to appraise, prove and perfect in real world trail conditions that no computer simulation can hope to match. It's the feedback of these brutally uncompromising riders as well as our sponsored athletes that give the stamp of true trail authority or send us back to the drawing board again.

Whyte 146 XI Whyte 146 Works Whyte 146 S										
Frame Size	A	B	C	D	E	F	G	H	I	J
S	66°	73.5°	576	338	795	1136	440	30.9	115	406 (16")
M	66°	73.5°	599	338	803	1159	440	30.9	120	445 (17.5")
L	66°	73.5°	624	338	810	1185	440	30.9	125	483 (19")
Whyte T-129 Whyte T-129 S										
Frame Size	A	B	C	D	E	F	G	H	I	J
S	68°	73.5°	596	343	808	1125	431	30.9	100	406 (16")
M	68°	73.5°	616	343	808	1145	431	30.9	100	445 (17.5")
L	68°	73.4°	631	343	811	1160	431	30.9	110	483 (19")
Whyte 929										
Frame Size	A	B	C	D	E	F	G	H	I	J
S	67.7°-68.3°	73.2°-73.8°	610	305	799	1119-1139	425-445	30.9	100	406 (16")
M	67.7°-68.3°	73.2°-73.8°	625	305	814	1136-1156	425-445	30.9	100	445 (17.5")
L	67.7°-68.3°	73.2°-73.8°	638	305	841	1149-1169	425-445	30.9	120	483 (19")
Whyte 905										
Frame Size	A	B	C	D	E	F	G	H	I	J
S	67.2°-67.8°	72.2°-72.8°	565	323	774	1072-1092	415-435	30.9	122	406 (16")
M	67.2°-67.8°	72.2°-72.8°	585	323	800	1092-1122	415-435	30.9	132	455 (17.9")
L	67.2°-67.8°	72.2°-72.8°	610	323	826	1119-1139	415-435	30.9	152	491 (19.3")
XL	67.2°-67.8°	72.2°-72.8°	629	323	853	1144-1164	415-435	30.9	160	533 (21")
Whyte 901										
Frame Size	A	B	C	D	E	F	G	H	I	J
S	67.5°	72.5°	565	323	774	1082	425	30.9	122	406 (16")
M	67.5°	72.5°	585	323	800	1102	425	30.9	132	455 (17.9")
L	67.5°	72.5°	610	323	826	1129	425	30.9	152	491 (19.3")
XL	67.5°	72.5°	629	323	853	1154	425	30.9	160	533 (21")
Whyte M-109 Whyte M-109 S										
Frame Size	A	B	C	D	E	F	G	H	I	J
S	69.5°	73.6°	595	335	795	1105	431	30.9	100	406 (16")
M	69.5°	73.5°	615	335	795	1125	431	30.9	105	445 (17.5")
L	69.5°	73.4°	631	335	800	1140	431	30.9	115	483 (19")

Whyte 29er C Team Whyte 29er CS Whyte 29er C										
Frame Size	A	B	C	D	E	F	G	H	I	J
S	69.3°	73°	612	304	860	1117	438	30.9	100	431 (17")
M	69.3°	73°	627	304	880	1128	438	30.9	110	470 (18.5")
L	69.3°	73°	641	304	910	1145	438	30.9	120	521 (20.5")
Whyte 20-C Team Whyte 20-CS Whyte 20-C										
Frame Size	A	B	C	D	E	F	G	H	I	J
S	68.5°	73.5°	585	300	755	1094	425	30.9	107	406 (16")
M	68.5°	73.5°	604	300	775	1114	425	30.9	125	444 (17.5")
Whyte 729 Whyte 629 Whyte 529										
Frame Size	A	B	C	D	E	F	G	H	I	J
S	68.5°	73°	600	305	809	1113	440	30.9	110	432 (17")
M	68.5°	73°	615	305	827	1128	440	30.9	115	470 (18.5")
L	68.5°	73°	629	305	852	1143	440	30.9	120	521 (20.5")
Whyte 805 Whyte 802 Whyte 801										
Frame Size	A	B	C	D	E	F	G	H	I	J
S	68.5°	73.5°	581	305	765	1091	425	30.9	115	406 (16")
M	68.5°	73.5°	596	305	788	1107	425	30.9	125	444 (17.5")
L	68.5°	73°	596	305	815	1122	425	30.9	135	483 (19")
XL	68.5°	73°	626	305	835	1134	425	30.9	145	533 (21")
Whyte Coniston Whyte Chiltern Whyte Caledonian Whyte Malvern										
Frame Size	A	B	C	D	E	F	G	H	I	J
S	69°	74°	592	288	784	1101	435	30.9	115	457 (18")
M	69°	73.5°	617	288	815	1121	435	30.9	125	495 (19.5")
L	69°	73°	632	288	842	1131	435	30.9	135	546 (21.5")
Whyte Caledonian Women's Whyte Malvern Women's										
Frame Size	A	B	C	D	E	F	G	H	I	J
S	68°	74.5°	560	288	728	1073	435	30.9	107	432 (17")
M	69°	74°	587	288	747	1085	435	30.9	115	457 (18")
L	69°	73.5°	612	288	767	1105	435	30.9	125	495 (19.5")

Whyte Saxon Cross Team Whyte Saxon Cross										
Frame Size	A	B	C	D	E	F	G	H	I	J
51cm	69.3°	74.5°	538	279	784	1036	425	27.2	130	510 (20.1")
53cm	69.3°	74°	558	279	799	1057	430	27.2	145	530 (20.9")
55cm	69.3°	73.5°	585	279	813	1075	430	27.2	160	550 (21.7")
57cm	69.3°	72.5°	600	279	829	1080	435	27.2	175	570 (22.4")
Whyte Charing Cross Whyte Kings Cross										
Frame Size	A	B	C	D	E	F	G	H	I	J
51cm	69.3°	74.5°	543	272	777	1041	425	27.2	130	510 (20.1")
53cm	69.3°	74°	567	272	792	1066	430	27.2	145	530 (20.9")
55cm	69.3°	73.5°	591	272	806	1086	430	27.2	160	550 (21.7")
57cm	69.3°	73°	610	272	822	1106	435	27.2	175	570 (22.4")
59cm	69.3°	73°	629	272	837	1126	435	27.2	190	590 (23.2")
Whyte Montpellier Whyte Stirling Whyte Cambridge Whyte Cambridge Varsity Whyte Portobello										
Frame Size	A	B	C	D	E	F	G	H	I	J
S	69.5°	74°	572	272	717	1052	420	27.2	120	406 (16")
M	70°	73.5°	597	272	743	1069	420	27.2	140	444 (17.5")
L	70°	73°	611	272	779	1079	420	27.2	160	495 (19.5")
XL	70°	73°	625	272	805	1094	420	27.2	180	533 (21")
Whyte Victoria										
Frame Size	A	B	C	D	E	F	G	H	I	J
XS	69°	74°	550	272	697	1038	420	27.2	110	381 (15")
S	69°	74.5°	549	272	700	1069	420	27.2	115	394 (15.5")
M	69.5°	73.5°	574	272	730	1084	420	27.2	135	432 (17")

TRAIL SUSPENSION				
Model	Whyte 146 XI	Whyte 146 Works	Whyte 146 S	Whyte T-129
Colour	Matt/Gloss UD with Grey Decals	Matt/Gloss UD with Aqua Decals	Matt/Gloss UD with Burned Orange Decals	Matt Granite and Aqua
Sizes Available	S, M, L	S, M, L	S, M, L	S, M, L
Frame	Uni-directional Monochoque Front Triangle with Torque tube, Single Monochoque Rear Swingarm, Modular Dropouts	Uni-directional Monochoque Front Triangle with Torque tube, Single Monochoque Rear Swingarm, Modular Dropouts	Uni-directional Monochoque Front Triangle with Torque tube, Single Monochoque Rear Swingarm, Modular Dropouts	6061 T6 Alloy Front Triangle with Tapered Head Tube and alloy rear Triangle with Maxle 142 dropouts
Fork	Fox 34 Float 150 CTD FIT Factory Series, Kashima Coating, QR15, Tapered Steerer Tube, Adjustable Rebound and Compression Adjustment	Fox 34 Float 150 CTD FIT Factory Series, QR15, Tapered Steerer Tube, Adjustable Rebound and Compression Adjustment	Fox 34 Float 150 CTD FIT Performance Series, QR15 Tapered Steerer Tube, Adjustable Rebound and Compression Adjustment	Rockshox Reba 29", RL1, 120mm Travel, Tapered steerer and 15mm Maxle
Rear Shock	Fox Float CTD Factory with Boost Valve, Kashima Coating, Rebound Adjustment and Adjustable CTD Adjust	Fox Float CTD Factory with Boost Valve, Rebound Adjustment and Adjustable CTD Adjust	Fox Float CTD Performance with Boost Valve, Rebound Adjustment and Adjustable CTD Adjust	Rockshox Monarch, RL, with Adjustable Rebound and Compression
Headset	FSA Orbit ZS, Sealed Cartridge Bearings, 1.5" Lower, 1 1.8" Upper Bearings	FSA Orbit ZS, Sealed Cartridge Bearings, 1.5" Lower, 1 1.8" Upper Bearings	FSA Orbit ZS, Sealed Cartridge Bearings, 1.5" Lower, 1 1.8" Upper Bearings	FSA Orbit ZS, 1.5" Cartridge Sealed Lower Bearing Lower and 1 1.8" Upper Bearing
Rear Hub	SRAM RISE 60, Full Carbon tubeless system wheels, 12mm X 142 Shimano E-Thru	Easton EA-90 12mm X 142 Shimano E-Thru	Easton EA70-XCT 12mm X 142 Shimano E-Thru	Alloy, Double Sealed Bearing Hub 12mm X 142mm Through Axle, 32 Hole
Front Hub	SRAM RISE 60, QR15	Easton EA-90 QR15	Easton EA70-XCT QR15	Alloy, Double Sealed Bearing Hub 15mm Through Axle, 32 Hole
Spokes	SRAM RISE 60	Easton EA-90	Easton EA70-XCT	WTB Double Butted, Black Sandvik Stainless Steel Spokes
Rims	SRAM RISE 60, Full Carbon tubeless system	Easton EA-90, UST Tubeless	Easton EA70-XCT, UST Tubeless Rims	WTB STI19 29" Rims with TCS System, Tubeless Ready
Tyres	Maxxis Ardent 26 x 2.25" Kevlar Bead Front, Maxxis Crossmark 2.1" 120 TPI Rear	Maxxis Ardent 26 x 2.25" Kevlar Bead Front, Maxxis Crossmark 2.1" 120 TPI Rear	Maxxis Ardent 26 x 2.25" Kevlar Bead Front, Maxxis Crossmark 2.1" 120 TPI Rear	WTB Wolverine, 29" X 2.2" Folding Front, WTB Nano, 29" X 2.1" Rear
Shift Levers	SRAM XX1 Matchmaker, 11 Speed	SRAM X-0 Matchmaker, 10 Speed	SRAM X-9 Matchmaker, 10 Speed	SRAM X-7, 10 Speed
Front Derailleur	N/A	SRAM X-0, 10 Speed	SRAM X-9, 10 Speed	SRAM X-7, High Direct Mount, 10 Speed
Rear Derailleur	SRAM XX1, 11 Speed	SRAM X-0, Type 2, 10 Speed	SRAM X-9 Type 2, 10 Speed	SRAM X-9, Type 2, 10 Speed
Cassette	SRAM XX1, 10-42T, 11 Speed	SRAM PG-1080, 11-36T, 10 Speed	CS PG-1050, 11-36, 10 Speed	SRAM PG-1030 11-36, 10 Speed
Chain	SRAM PC-XX1, 11 Speed	SRAM, 10 Speed	SRAM, 10 Speed	SRAM PC-1031, 10 Speed
Crankset	SRAM XX1 Press Fit-30, 34 11 Speed Single	SRAM X-0 Press Fit-30, 26-39, 10 Speed, Compact Double	SRAM X-9 Press Fit-30, 26-39, 10 Speed, Compact Double	SRAM S1000 GXP, 38-24 29er Ratio Compact Double, 10 Speed
Bottom Bracket	Press Fit-30	Press Fit-30	Press Fit-30	SRAM GXP
Seatpost	Rock Shox REVERB Stealth, 30.9mm x 420mm	Rock Shox REVERB Stealth, 30.9mm x 420mm	Whyte Alloy 2014, 30.9mm x 410mm, 2 Bolt Clamp	Whyte Alloy 2014, 30.9mm x 410mm, 2 Bolt Clamp
Seat	Fi'zi:k Gobi XM Black Matt/Gloss	Fi'zi:k Gobi XM	Fi'zi:k Gobi XM	Whyte Custom dual density, triple panel design
Bar	Easton Havoc Carbon Low Rise, 31.8mm OD, 711mm Wide	Easton Haven Carbon Low Rise, 31.8mm OD, 711mm Wide	Easton Haven Alloy Low Rise, 31.8mm, 711mm Wide	Whyte Custom 2014 Alloy, 20mm Rise, 710mm Wide
Stem	Easton Haven, 31.8mm Bar Clamp, 70mm S, 70mm M, 85mm L	Easton Haven, 31.8mm Bar Clamp, 70mm S, 70mm M, 85mm L	Whyte, 31.8mm Bar Clamp, 70mm S and M, 80mm L	Whyte, 31.8mm Bar Clamp, 70mm S, 80mm M & L
Grips	Whyte Lock-on	Whyte Lock-on	Whyte Lock-on	Whyte Lock-on
Front Brake	Avid Elixir X-0 Trail, 4 pot callipers with 180mm Rotor	Avid Elixir X-0 Trail, 4 pot callipers with 180mm Rotor	Avid Elixir 7, 180mm Rotor	Avid Elixir 3, 180mm Rotor
Rear Brake	Avid Elixir X-0 Trail, 4 pot callipers with 170mm Rotor	Avid Elixir X-0, 160mm Rotor	Avid Elixir 7, 160mm Rotor	Avid Elixir 3, 160mm Rotor
Brake Levers	Avid Elixir X-0 Trail Matchmaker	Avid Elixir X-0 Trail/X-0 Matchmaker	Avid Elixir 7 Matchmaker	Avid Elixir 3
Pedals	None	None	None	None

Specification details were correct at the time of printing. However, product changes may occur after this time.
Please check model availability and full specification details with your dealer prior to ordering.

	TRAIL SUSPENSION		TRAIL HT	
Model	Whyte T-129 S	Whyte 929	Whyte 905	Whyte 901
Colour	Matt Granite and Lime	Granite Matt with Nickle Decals	White Matt with Gloss Black and Grey Decals	Zinc Matt with Gloss Lime Green
Sizes Available	S, M, L	S, M, L	S, M, L, XL	S, M, L, XL
Frame	6061 T6 Alloy Front Triangle with Tapered Head Tube and alloy rear triangle with Maxle 142 dropouts	6061 Hydro Formed T6 Aluminium, Custom Drawn and Multi Butted, Tapered Headtube and Adjustable Modular Dropouts and ISCG chainguide mounts	6061 Hydro Formed T6 Aluminium, Custom Drawn and Multi Butted, with Press Fit BB Shell and Tapered Headtube and Whyte's adjustable dropout system	6061 Hydro Formed T6 Aluminium, Custom Drawn and Multi Butted, Tapered Headtube
Fork	Rockshox Reba 29", RLT, 120mm Travel, Tapered steerer and 15mm Maxle	Fox 32 F29 CTD FIT Performance, 120mm, Tapered Steerer and 15QR, Adjustable Rebound and Compression Adjustment	Fox 32 CTD Evolution, 120mm Travel, Tapered Steerer and 15QR	RockShox Recon Gold TK Lock-out, Maxle Light 120mm Travel, Solo Air, Adjustable Compression, Tapered Steerer
Rear Shock	Rockshox Monarch, RT3, Adjustable Rebound and Compression	N/A	N/A	N/A
Headset	FSA Orbit ZS, 1.5" Cartridge Sealed Lower Bearing Lower and 1.1.8" Upper Bearing	FSA Orbit ZS, Sealed Cartridge Bearings, 1.5" Lower, 1.1.8" Upper Bearings	FSA Orbit ZS, Sealed Cartridge Bearings, 1.5" Lower, 1.1.8" Upper Bearings	FSA Orbit ZS, Sealed Cartridge Bearing 1.5" Lower, 1.1.8" Caged Upper Bearings
Rear Hub	Alloy, Double Sealed Bearing Hub 12mm X 142mm Through Axle, 32 Hole	Hope EVO Disc, 32 Hole with Shimano XT QR	Hope EVO Disc, 32 Hole with Shimano XT QR	Alloy, Double Sealed, 32 Hole
Front Hub	Alloy, Double Sealed Bearing Hub 15mm Through Axle, 32 Hole	Alloy, Cartridge sealed Bearing Hub 15mm, 32 Hole	Alloy, Double Sealed Bearing Hub 15mm, 32 Hole	Alloy, Double Sealed Bearing Hub 15mm Through Axle, 32 Hole
Spokes	WTB Double Butted, Black Sandvik Stainless Steel Spokes	WTB 15g, Silver Stainless with Brass Nipples	DT Champion 15 gauge Black Stainless with Brass Nipples	WTB 15g, Black Stainless with Brass Nipples
Rims	WTB ST119 29" Rims with TCS System, Tubeless Ready	WTB ST1 29er, TCS Tubeless system, with custom graphics	Mavic XM 319, 32 Hole	Mavic XM 119 Disc Noir, 32 Hole
Tyres	Maxxis Ardent, 29" X 2.25" 120TPI Folding Bead, Maxxis IKON, 29" X 2.2" 60TPI Folding Bead Rear	Maxxis Ardent 29 x 2.25" 60 TPI with Kevlar Bead Front, Maxxis IKON 2.2" 60 TPI Rear	Maxxis Aspen 26" x 2.25", DK60 AR Folding Bead	Continental Mountain King Folding 26" x 2.2"
Shift Levers	SRAM X-9 Matchmaker, 10 Speed, Green	Shimano XT-780 I-Spec, 10 Speed	SRAM X-7, 10 Speed, Matchmaker	SRAM X-5, 10 Speed
Front Derailleur	SRAM X-7, High Direct Mount, 10 Speed	N/A	SRAM X-7, 10 Speed	SRAM X-5, 10 Speed
Rear Derailleur	SRAM X-9, Type 2, 10 Speed, Green	Shimano XT RD-M786 Shadow Plus, 10 Speed	SRAM X-9, Type 2 medium cage, 10 Speed	SRAM X-9 Type 2 Medium Cage, 10 Speed, Custom Green
Cassette	SRAM PG-1050 11-36, 10 Speed	Shimano XT CS-HG771 11-36, 10 Speed	SRAM PG-1050, 12-36, 10 Speed	SRAM PG-1030, 11-36, 10 Speed
Chain	SRAM PC-1031, 10 Speed	Shimano HG-54, 10 Speed	SRAM PC-1031	SRAM PC-1031, 10 Speed
Crankset	SRAM S1400 GXP, 38-24 29er Ratio Compact Double, 10 Speed	E-13 TRS, Press Fit 30 Single Chainset with 32 Tooth chaining,	SRAM S1400, GXP, 26-39, 10 Speed, Compact Double	SRAM FC S1000, GXP, 39-26, 10 Speed, Double Compact
Bottom Bracket	SRAM GXP	Press Fit 30	SRAM GXP	SRAM GXP
Seatpost	X-Fusion Hilo remotely Adjustable Dropper post, 30.9 X 400mm	Whyte 20mm Offset, 30.9mm x 400mm, 2014 Alloy, 2 Bolt Clamp	Whyte 20mm Offset, 30.9mm x 400mm, 2014 Alloy, 2 Bolt Clamp	Whyte 20mm Offset, 30.9mm x 400mm, 2014 Alloy, 2 Bolt Clamp
Seat	Whyte Custom dual density, triple panel design	Fi'zi:k Gobi XM	Fi'zi:k Gobi XM, Mag Rails	Whyte Custom, Triple Panel Design
Bar	Whyte Custom 2014 Alloy, 20mm Rise, 710mm Wide	Whyte Custom 2014 Alloy, flat, 700mm Wide	Whyte Custom 2014 Alloy, Low Rise, 710mm Wide	Whyte Custom 2014 Alloy, Low Rise, 710mm Wide
Stem	Whyte, 31.8mm Bar Clamp, 70mm S, 80mm M & L	Whyte Custom, 70mm S and M, 80mm L	Whyte Custom, 70mm S, 80mm M, 90mm L and XL	Whyte Custom, 70mm S, 80mm M, 90mm L and XL
Grips	Whyte Lock-on	Whyte Custom Lock-on	Whyte Custom Lock-on	Whyte Custom Lock-on
Front Brake	Avid Elixir 5, 180mm Rotor	Shimano XT BR-M785, 203mm Rotor	Avid Elixir 5, 180mm Rotor	Avid Elixir 3, 180mm Rotor
Rear Brake	Avid Elixir 5, 160mm Rotor	Shimano XT BR-M785, 160mm Rotor	Avid Elixir 5, 160mm Rotor	Avid Elixir 3, 160mm Rotor
Brake Levers	Avid Elixir 5 Matchmaker	Shimano XT BL-M785 I-Spec	Avid Elixir 5, Matchmaker	Avid Elixir 3
Pedals	None	N/A	None	None

Specification details were correct at the time of printing. However, product changes may occur after this time. Please check model availability and full specification details with your dealer prior to ordering.

	XC MARATHON		CARBON HT	
Model	Whyte M-109	Whyte M-109 S	Whyte 29er C Team	Whyte 29er CS
Colour	White Matt and Apple	White Matt and Aqua	UD Matt Carbon and White and Orange Decals	UD Matt Carbon and White and Apple Decals
Sizes Available	S, M, L	S, M, L	S, M, L	S, M, L
Frame	6061 T6 Alloy Front Triangle with Tapered Head Tube and alloy rear Triangle with E-Thru dropouts	6061 T6 Alloy Front Triangle with Tapered Head Tube and alloy rear Triangle with E-Thru dropouts	Uni-directional Multi Monocoque, with Post Mount chainstay mounted disk brake and full carbon dropouts	Uni-directional Multi Monocoque, with Post Mount chainstay mounted disk brake and full carbon dropouts
Fork	Fox Float 32 Evolution 29", 100mm Travel, Tapered steerer and 15QR	Fox Float 32 Performance 29" with CTD, 100mm Travel, Tapered steerer and 15QR	RockShox SID RLT, 100mm Travel, 15mm Maxle Lite, Matchmaker PushLock Remote lockout	RockShox SID RLT, 100mm Travel, 15mm Maxle Lite, Matchmaker PushLock Remote lockout
Rear Shock	Float CTD Evolution, Rebound Adjustment and CTD Adjust	Float CTD Performance with Boost Valve and Rebound Adjustment and CTD Adjust	N/A	N/A
Headset	FSA Orbit ZS, 1.5" Cartridge Sealed Lower Bearing Lower and 1 1.8" Upper Bearing	FSA Orbit ZS, 1.5" Cartridge Sealed Lower Bearing Lower and Cartridge Bearing 1 1.8" Upper Bearing	FSA Integrated, Orbit ZS Plus, 1 1/8" - 1 1/2" Sealed Cartridge Bearings	FSA Integrated, Orbit ZS Plus, 1 1/8" - 1 1/2" Sealed Cartridge Bearings
Rear Hub	Whyte XC-209 Wheelset, 32 StSt flat spokes, 6 Bolt hub with double sealed cartridge bearings	Whyte XC-209-C Carbon Wheelset, 32 StSt spokes, QR15, 6 Bolt hub with double sealed cartridge bearings	Whyte XC-209-C Carbon Wheelset, 32 StSt spokes, 6 Bolt hub with double sealed cartridge bearings	Easton EA70-XCT Wheelset, 6 Bolt, UST Tubeless Compatible
Front Hub	Whyte XC-209 Wheelset, 28 StSt flat spokes, 6 Bolt hub with double sealed cartridge bearings	Whyte XC-209-C Carbon Wheelset, 32 StSt spokes, 12mm E-Tru, 6 Bolt hub with double sealed cartridge bearings	Whyte XC-209-C Carbon Wheelset, 28 StSt spokes, 6 Bolt hub with double sealed cartridge bearings	Easton EA70-XCT Wheelset, 6 Bolt, 15mm, UST Tubeless Compatible
Spokes	Black Stainless Steel Spokes	DT Competition Triple Butted	DT Competition Triple Butted	Easton XEA70-XCT
Rims	Whyte XC-209	Whyte X-C-209-C uni directional High-Modulus Carbon, with 1K Shock skin	Whyte X-C-209-C Uni-Directional High-Modulus Carbon, with 1K Shock skin	Easton EA70-XCT, UST Tubeless Compatible
Tyres	Maxxis IKON, 120TPI, 29" X 2.2" Folding	Maxxis IKON, 120TPI, 29" X 2.2" Folding	Maxxis IKON, 120TPI Folding Bead, 29" x 2.2"	Maxxis IKON, 120TPI Folding Bead, 29" x 2.2"
Shift Levers	Shimano Deore, 10 Speed	Shimano XT, 10 Speed	Shimano XT I Spec, 10 Speed	SRAM X-9, Matchmaker, 10 Speed
Front Derailleur	Shimano SLX, High Direct Mount, 10 Speed	Shimano SLX, High Direct Mount, 10 Speed	Shimano XT, 10 Speed	SRAM X-0, 10 Speed, Green
Rear Derailleur	Shimano SLX, Shadow Plus, 10 Speed	Shimano XT, Shadow Plus, 10 Speed	Shimano XTR M985, Shadow Plus, 10 Speed	SRAM X-0 Type 2 Medium Cage, 10 Speed, Green
Cassette	Shimano HG62-10 11-36, 10 Speed	Shimano HG81-10 11-36, 10 Speed	Shimano XT CS-M771, 11-36, 10 Speed	SRAM PG-1070, 11-36, 10 Speed
Chain	Shimano HG54, 10 Speed	Shimano HG54, 10 Speed	FSA Team Issue, 10 Speed	FSA Team Issue, 10 Speed
Crankset	Shimano SLX, Hollow Tech II, 42-32-24, 10 Speed	Shimano XT, Hollow Tech II, 42-32-24, 10 Speed	FSA SL-K UD Carbon, PressFit30, 39-27 29er Ratio Compact Double, 10 Speed	FSA SL-K UD Carbon, PressFit30, 38-24 29er Ratio Compact Double, 10 Speed
Bottom Bracket	Shimano Hollow Tech II	Shimano Hollow Tech II	FSA PressFit 30	FSA PressFit 30
Seatpost	Whyte Alloy 2014, 30.9mm x 410mm, 2 Bolt Clamp	Whyte Alloy 2014, 30.9mm x 410mm, 2 Bolt Clamp	FSA SL-K, UD Carbon, 30.9mm x 400mm	Whyte Custom 2014 Alloy, 30.9mm x 400mm, 2 bolt clamp
Seat	Whyte Custom dual density, triple panel design	Whyte Custom dual density, triple panel design	Fizik Tundra II, Mag Rails	Whyte Custom dual density, triple panel design
Bar	Whyte Custom 2014 Alloy, Flat, 700mm Wide	Whyte Custom 2014 Alloy, Flat, 700mm Wide	FSA SL-K UD Carbon Flat Bar, 31.8mm, 700mm Wide	FSA SL-K UD Carbon, Flat Bar, 31.8mm, 700mm Wide
Stem	Whyte, 31.8mm Bar Clamp, 70mm S, 80mm M, 90mm L	Whyte, 31.8mm Bar Clamp, 70mm S, 80mm M, 90mm L	Whyte Custom, -6 Degree, 70mm S and M and 80mm L	Whyte Custom, -6 Degree, 70mm S and M and 80mm L
Grips	Whyte Lock-on	Whyte Lock-on	Whyte Race, Foam Lock-on	Whyte Race, Foam Lock-on
Front Brake	Shimano BR596, 180mm XT Rotor	Shimano XT BR785, 180mm Rotor	Shimano XT I Spec, 180mm Rotor	Avid Elixir 7, Matchmaker, 170mm Rotor
Rear Brake	Shimano BR596, 160mm Rotor	Shimano XT BR785, 160mm Rotor	Shimano XT I Spec, 160mm Rotor	Avid Elixir 7, Matchmaker, 160mm Rotor
Brake Levers	Shimano BR596	Shimano XT BR785	Shimano XT	Avid Elixir 7
Pedals	None	None	N/A	N/A

Specification details were correct at the time of printing. However, product changes may occur after this time. Please check model availability and full specification details with your dealer prior to ordering.

CARBON HT				
Model	Whyte 29er C	Whyte 20-C Team	Whyte 20-CS	Whyte 20-C
Colour	UD Matt Carbon with White and Aqua Decals	UD Matt Carbon with White and Red Decals	UD Matt Carbon and White and Apple Decals	UD Matt Carbon with White and Aqua Decals
Sizes Available	S, M, L	S, M	S, M	S, M
Frame	Uni-directional Multi Monocoque, with Post Mount chainstay mounted disk brake and full carbon dropouts	Uni-directional Multi Monocoque, with Post Mount chainstay mounted disk brake and full carbon dropouts	Uni-directional Multi Monocoque, with Post Mount chainstay mounted disk brake and full carbon dropouts	Uni-directional Multi Monocoque, with Post Mount chainstay mounted disk brake and full carbon dropouts
Fork	Rockshox Reba RL, 100mm Travel, Tapered Steerer, Matchmaker PushLock Remote Lockout	Fox Float 32, 100mm Travel, Factory, TerraLogic, Tapered Steerer	RockShox SID RLt, 100mm Travel, Matchmaker PushLock Remote Lockout	Rockshox Reba RL, 100mm Travel, Tapered Steerer, Matchmaker PushLock Remote Lockout
Rear Shock	N/A	N/A	N/A	N/A
Headset	FSA Integrated, Orbit ZS Plus, 1 1/8" - 1 1/2" Sealed Cartridge Bearings	FSA Integrated, Orbit ZS Plus, 1 1/8" - 1 1/2" Sealed Cartridge Bearings	FSA Integrated, Orbit ZS Plus, 1 1/8" - 1 1/2" Sealed Cartridge Bearings	FSA Integrated, Orbit ZS Plus, 1 1/8" - 1 1/2" Sealed Cartridge Bearings
Rear Hub	Whyte XC-209 Wheelset, 32 SiSt spokes, 6 Bolt hub with double sealed cartridge bearings	Easton EC-70, Uni-Directional Carbon Wheelset	Easton EA70-XCT Custom Wheelset, 6 Bolt, UST Tubeless Compatible	Whyte XC-202 Wheelset, 28 SiSt spokes, 6 Bolt hub with double sealed cartridge bearings
Front Hub	Whyte XC-209 Wheelset, 28 SiSt spokes, 6 Bolt hub, double sealed cartridge bearing	Easton EC-70, Uni-Directional Carbon Wheelset	Easton EA70-XCT Custom Wheelset, 6 Bolt, UST Tubeless Compatible	Whyte XC-202 Wheelset, 24 SiSt spokes, 6 Bolt hub, double sealed cartridge bearing
Spokes	Stainless Steel Spokes	Easton EC-70	Easton EA70-XCT	Stainless Steel Spokes
Rims	Whyte XC - 209	Easton EC-70, Uni-Directional Carbon Wheelset	Easton EA70-XCT Custom, UST Tubeless Compatible	Whyte XC - 202
Tyres	Maxxis IKON, 60TPI Folding Bead, 29" x 2.2"	Maxxis Aspen 120TPI 26" x 2.1", Folding Bead	Continental "X" King, 2.2 X 26", Folding Bead	Continental "X" King 2.2 X 26", Folding Bead
Shift Levers	SRAM X-9, 10 Speed	Shimano XTR SL-M980, 10 Speed, 1 Spec	SRAM X-9, 10 Speed with Matchmaker, Green	SRAM X-9, 10 Speed
Front Derailleur	SRAM X-7, 10 Speed	Shimano XTR FD-M985, 10 Speed	SRAM X-0 Type 2 Medium cage, 10 Speed, Green	SRAM X-7, 10 Speed
Rear Derailleur	SRAM X-9 Type 2 medium Cage, 10 Speed, White/Black	Shimano XTR RD-M985 Shadow Plus, 10 Speed	SRAM X-0 Medium Cage, 10 Speed, Green	SRAM X-9 Type 2 Medium Cage, 10 Speed
Cassette	SRAM PG-1030, 11-36, 10 Speed	Shimano XTR CS-M980, 11-36, 10 Speed	SRAM PG-1070, 11-36, 10 Speed	SRAM PG-1030, 11-32, 10 Speed
Chain	SRAM 1031 with Power Link, 10 Speed	FSA Team Issue, 10 Speed	FSA Team Issue, 10 Speed	FSA Team Issue, 10 Speed
Crankset	SRAM S1000 PressFit30, 38/24, 29er Ratio Compact Double, 10 Speed	FSA SL-K UD Carbon 39-27, 10 Speed, Compact Double	FSA SL-K UD Carbon, BB30, 42-27, 10 Speed, Compact Double	FSA Comet PressFit30, 39-27, 10 Speed, Compact Double
Bottom Bracket	SRAM PressFit 30	FSA PressFit 30	FSA PressFit30	FSA PressFit 30
Seatpost	Whyte Custom 2014 Alloy, 30.9mm x 400mm, 2 bolt clamp	FSA SL-K UD Carbon 27.2mm X 350mm	Whyte Custom 2014 Alloy, 27.2mm x 400mm, 2 bolt clamp	Whyte Custom 2014 Alloy, 27.2mm x 400mm, 2 bolt clamp
Seat	Whyte Custom dual density, triple panel design	Fi'zi:k Tundra II, Mag Rails	Whyte Custom, Dual Density, triple panel design	Whyte Custom Dual Density, triple panel design
Bar	Whyte Custom 2014 Alloy, Flat, 700mm Wide	FSA SL-K UD Carbon 31.8mm, 700mm Wide Riser	FSA SL-K UD Carbon Riser, 31.8mm, 700mm Wide Riser	Whyte Custom 2014 Alloy, Low Rise, 710mm Wide Riser
Stem	Whyte Custom, -6 Degree, 70mm S and M and 80mm Large	Whyte Custom, 80mm S, 90mm M	Whyte Custom, 80mm S, 90mm M	Whyte Custom, 80mm S, 90mm M
Grips	Whyte Race, Foam Lock-on	Whyte Race, Foam Lock-on	Whyte Race, Foam Lock-on	Whyte Race, Foam Lock-on
Front Brake	Avid Elixir 3, Matchmaker, 170mm Rotor	Shimano XTR BL-M988, 160mm Rotor	Avid Elixir 7, Matchmaker, 160mm Rotor	Avid Elixir 3, Matchmaker, 160mm Rotor
Rear Brake	Avid Elixir 3, Matchmaker, 160mm Rotor	Shimano XTR BL-M988, 160mm Rotor	Avid Elixir 7, Matchmaker, 160mm Rotor	Avid Elixir 3, Matchmaker, 160mm Rotor
Brake Levers	Avid Elixir 3	Shimano XTR BL-M988	Avid Elixir 7	Avid Elixir 3
Pedals	N/A	None	None	N/A

Specification details were correct at the time of printing. However, product changes may occur after this time. Please check model availability and full specification details with your dealer prior to ordering.

	XC HT 29ER			XC HT
Model	Whyte 729	Whyte 629	Whyte 529	Whyte 805
Colour	Granite Matt with Apple and White Decals	White Matt with Aqua and Black Decals	Jet Black Matt with Red and White Decals	White Matt with Apple and Black Decals
Sizes Available	S, M, L	S, M, L	S, M, L	S, M, L, XL
Frame	6061 Hydro Formed T6 Aluminium, Custom Drawn, Multi Butted with Post Mount Dropouts	6061 Hydro Formed T6 Aluminium, Custom Drawn, Multi Butted with Post Mount Dropouts	6061 Hydro Formed T6 Aluminium, Custom Drawn, Multi Butted with Post Mount Dropouts	6061 Hydro Formed T6 Aluminium, Custom Drawn, Multi Butted with Post Mount Dropouts
Fork	RockShox REBA RL 100mm Travel, Alloy Tapered Steerer, Rebound and Compression adjust	RockShox XC-32 TK 29, 100mm Travel, Alloy Tapered Steerer and Lock out and rebound	RockShox XC 28, 100mm Travel, Adjustable Rebound, Turn Key Lockout	RockShox XC-30 TK, 100mm Travel, Adjustable Rebound, Turn Key Lockout
Rear Shock	N/A	N/A	N/A	N/A
Headset	FSA No. 10 upper and 1.5" lower external cup Caged Bearings	FSA No. 10 upper and 1.5" lower external cup Caged Bearings	FSA No. 10 Caged Bearings	FSA No. 10 Caged Bearings
Rear Hub	Whyte XC-209 Wheelset, 32 Stif flat spokes, 6 Bolt hub with double sealed cartridge bearings	Whyte Alloy Double Sealed 32 Hole Rear, 28 Hole Front	Alloy, Double Sealed Bearing Hub, 32 Hole	Alloy, Double Sealed Bearing Hub, 32 Hole, Green Anodize
Front Hub	Whyte XC-209 Wheelset, 28 Stif flat spokes, 6 Bolt hub, double sealed cartridge bearing	Whyte Alloy Cartridge Bearing hub with 28mm Flange 32 Hole	Alloy, Double Sealed Bearing Hub, 32 Hole	Alloy, Double Sealed Bearing Hub, 32 Hole, Green Anodize
Spokes	Black Stainless Steel Spokes	WTB 15g, Black Stainless with Brass Nipples	WTB 15g, Black Stainless with Brass Nipples	WTB 15 Gauge, Black Stainless with Brass Nipples
Rims	Whyte XC-209	Whyte XC-229 Rims, 32 Hole Rear, 28 Hole Front	Whyte XC-29, 32 Hole	Whyte XC-22, 32 Hole
Tyres	Maxxis IKON, 120TPI, 29" X 2.2" Folding	Maxxis IKON 60TPI, 29" x 2.2", Folding	Maxxis IKON 60TPI, 29" x 2.2", Folding	X King 26" x 2.2", Folding
Shift Levers	SRAM X-9 Matchmaker, 10 Speed, Custom Green	SRAM X-5, 10 Speed	Shimano Acera, 9 Speed	SRAM X-5, 10 Speed
Front Derailleur	SRAM X-7, 10 Speed	SRAM X-5, 10 Speed	Shimano Acera, 9 Speed	SRAM X-5, 10 Speed
Rear Derailleur	SRAM X-9 Type 2, Medium Cage, 10 Speed Custom Green	SRAM X-7, Medium Cage, 10 Speed	Shimano Deore RD-M592 Shadow	SRAM X-7, Long Cage, 10 Speed
Cassette	SRAM PG-1050, 11-36, 10 Speed	Shimano CS-HG63-10, 11-36, 10 Speed	Shimano HG-20, 11-34, 9 Speed	SRAM PG-1030 11-36, 10 Speed
Chain	FSA Team Issue, 10 Speed	FSA Team Issue, 10 Speed	KMC X9, 9 Speed	FSA Team Issue, 10 Speed
Crankset	SRAM S1400 GXP, 24-38 29er Ratio Compact Double, 10 Speed	SRAM S1000 GXP, 24-38 29er Ratio Compact Double, 10 Speed	Shimano M391, 44-32-22, 9 Speed	SRAM FC800, 44-32-22 with Power Spline, 10 Speed
Bottom Bracket	SRAM GXP	SRAM GXP	Shimano BB-ES25 Square Taper	SRAM Power Spline
Seatpost	Whyte 20mm Offset, 30.9mm x 400mm, 2014 Alloy, 2 Bolt Clamp	Whyte 20mm Offset, 30.9mm x 400mm, 2014 Alloy, 2 Bolt Clamp	Whyte 20mm Offset, 30.9mm x 400mm, 6061 Alloy, 2 Bolt Clamp	Whyte 20mm Offset, 30.9mm x 400mm, 6061 Alloy, 2 Bolt Clamp
Seat	Whyte Custom dual density, triple panel design	Whyte Custom, Triple Panel Design	Whyte Custom	Whyte Custom, Triple Panel Design
Bar	Whyte Flat 29er 2014 Bar, 31.8mm, 700mm Wide	Whyte Flat 29er 6061 Bar, 31.8mm, 700mm Wide	Whyte Flat 29er 6061 Bar, 31.8mm, 700mm Wide	Whyte Riser Bar 30mm rise, 31.8mm, 680mm Wide
Stem	Whyte Custom, 70mm S, 70mm M, 90mm L	Whyte Custom, 70mm S, 70mm M, 90mm L	Whyte Custom, 70mm S, 70mm M, 80mm L	Whyte Custom, 70mm S, 70mm M, 90mm L & XL
Grips	Whyte Custom Lock-on	Whyte Custom Lock-on	Whyte Custom Lock-on	Whyte Custom Lock-on
Front Brake	Avid Elixir 5 Matchmaker, 170mm Rotor	Avid Elixir 1, 170mm Rotor	Tektro Draco 2, 160mm rotor	Avid Elixir 1, 160mm Rotor
Rear Brake	Avid Elixir 5 Matchmaker, 160mm Rotor	Avid Elixir 1, 160mm Rotor	Tektro Draco 2, 160mm rotor	Avid Elixir 1, 160mm Rotor
Brake Levers	Avid Elixir 5 Matchmaker	Avid Elixir 1	Tektro Draco 2	Avid Elixir 1
Pedals	N/A	VP Full Alloy with Toe Clip	VP Composite with Alloy Cage and Toe Clip	VP Composite with Alloy Cage and Toe Clip

Specification details were correct at the time of printing. However, product changes may occur after this time. Please check model availability and full specification details with your dealer prior to ordering.

	XC HT		C7 ALL TERRAIN	
Model	Whyte 802	Whyte 801	Whyte Coniston	Whyte Chiltern
Colour	White Matt with Aqua and Black Decals	Matt Granite with Aqua and White Decals	Matte Granite with Purple	Matte Granite with Apple
Sizes Available	S, M, L	S, M, L, XL	S, M, L	S, M, L
Frame	6061 Hydro Formed T6 Aluminium, Custom Drawn and Multi Butted	6061 Hydro Formed T6 Aluminium, Custom Drawn, Multi Butted with Post Mount Dropouts	6061 Hydro Formed T6 Aluminium, Custom Drawn, Multi Butted with Custom Whyte Dropouts	6061 Hydro Formed T6 Aluminium, Custom Drawn, Multi Butted with Custom Whyte Dropouts
Fork	RockShox XC 28, 100mm Travel, Adjustable Rebound, Turn Key Lockout	RockShox Custom XC 28, 100mm Travel, Adjustable Rebound, Turn Key Lockout	SR Suntour NRX-E LO Lite, 63mm travel, Hydro Lock-out and Adjustable Rebound Control, Alloy Upper and Mag Lower legs	SR Suntour NCX-E LO Lite, 63mm travel, Air Spring, Hydro Lock-out, Alloy Upper legs with Alloy Steerer
Rear Shock	N/A	N/A	N/A	N/A
Headset	FSA No. 10 Caged Bearings	FSA No. 10 Caged Bearings	FSA Semi Integrated, 1 1/8" Sealed Cartridge Bearings	FSA Semi Integrated, 1 1/8" Sealed Cartridge Bearings
Rear Hub	Alloy, Double Sealed Bearing Hub, 32 Hole	Alloy, Double Sealed Bearing Hub, 32 Hole	SRAM 506 Alloy, Double Sealed Bearing Hub, 32 Hole	Alloy, Double Sealed Cartridge Bearings, 32 Hole
Front Hub	Alloy, Double Sealed Bearing Hub, 32 Hole	Alloy, Double Sealed Bearing Hub, 32 Hole	SRAM 506 Alloy, Double Sealed Bearing Hub, 32 Hole	Alloy, Double Sealed Cartridge Bearings, 32 Hole
Spokes	WTB 15g, Black Stainless with Brass Nipples	WTB 15g, Black Stainless with Brass Nipples	DT Champion 15g Black Stainless with Black Brass Nipples	DT Champion 15g Black Stainless with Black Brass Nipples
Rims	Whyte XC-20, 32 Hole	Whyte XC-20, 32 Hole	WTB SX-17 700c, 32 Hole with Eyelets	WTB SX-17 700c, 32 Hole with Eyelets
Tyres	Continental X-King Wire 26" x 2.2"	Continental X-King Wire 26" x 2.2"	WTB All Terrain Comp 700 x 35c, Folding with Flat Guard and Reflective Sidewall and Flat Guard	WTB All Terrain Comp 700 x 35c, Folding with Flat Guard and Reflective Sidewall and Flat Guard
Shift Levers	Shimano Acera, 9 Speed	Shimano Acera, 9 Speed	Shimano SLX, 10 Speed	Shimano Deore, 10 Speed
Front Derailleur	Shimano Acera, 9 Speed	Shimano Acera, 9 Speed	Shimano Deore, 10 Speed	Shimano LX, 10 Speed
Rear Derailleur	Shimano Deore RD-M592 Shadow	Shimano Deore RD-M592 Shadow	Shimano XT Shadow, 10 Speed	Shimano XT T780, 10 Speed
Cassette	Shimano HG-20, 11-34, 9 Speed	Shimano HG-20, 11-34, 9 Speed	Shimano CS-HG62, 11-34, 10 Speed	Shimano CS-HG62, 11-34, 10 Speed
Chain	KMC X9, 9 Speed	KMC X9, 9 Speed	Shimano HG-54, 10 Speed	Shimano HG-54, 10 Speed
Crankset	Shimano M391, 44-32-22, Silver, 9 Speed with 170mm Cranks	Shimano M391, 44-32-22, 9 Speed	Shimano T780 XT, Hollow Tech II, 48-36-26, 10 Speed	Shimano T551, Hollow Tech II, 48-36-26, 10 Speed
Bottom Bracket	Shimano BB-ES25 Square Taper	Shimano BB-ES25 Square Taper	Hollow Tech II	Hollow Tech II
Seatpost	Whyte 20mm Offset, 30.9mm x 400mm, 6061 Alloy, 2 Bolt Clamp	Whyte 20mm Offset, 30.9mm x 400mm, 6061 Alloy, 2 Bolt Clamp	Whyte 20mm Offset, 30.9mm x 400mm, 2014 Alloy, 2 bolt clamp	Whyte 20mm Offset, 30.9mm x 400mm, 2014 Alloy, 2 bolt clamp
Seat	Whyte Custom Women's fit	Whyte Custom	Whyte Custom, triple panel design	Whyte Custom, triple panel design
Bar	Whyte Riser Bar 30mm rise, 31.8mm, 680mm Wide	Whyte Riser Bar 30mm rise, 31.8mm, 680mm Wide	Whyte High Rise 30mm, 31.8mm, 620mm Wide	Whyte High Rise 30mm, 31.8mm, 620mm Wide
Stem	Whyte Custom, 70mm S, 70mm M, 90mm L & XL	Whyte Custom, 70mm S, 70mm M, 90mm L & XL	Whyte Custom, 70mm S, 80mm M, 90mm L	Whyte Custom, 70mm S, 80mm M, 90mm L
Grips	Whyte Custom Lock-on	Whyte Custom Lock-on	Whyte Custom Ergo Dual Density Lock-on's	Whyte Custom Ergo Dual Density Lock-on's
Front Brake	Tektro HDC 300, 160mm rotor	Tektro HDC 300, 160mm rotor	Shimano BR-M596, 160mm Rotor	Avid Elixir 1, 160mm Rotor
Rear Brake	Tektro HDC 300, 160mm rotor	Tektro HDC 300, 160mm rotor	Shimano BR-M596, 160mm Rotor	Avid Elixir 1, 160mm Rotor
Brake Levers	Tektro HDC 300	Tektro HDC 300	Shimano BR-M596	Avid Elixir 1
Pedals	VP Composite with Alloy Cage and Toe Clip	VP Composite with Alloy Cage and Toe Clip	VP Full Alloy with Toe Clip	VP Full Alloy with Toe Clip

Specification details were correct at the time of printing. However, product changes may occur after this time. Please check model availability and full specification details with your dealer prior to ordering.

	C7 ALL TERRAIN		C7 ALL TERRAIN WOMEN'S	
Model	Whyte Caledonian	Whyte Malvern	Whyte Caledonian Women's	Whyte Malvern Women's
Colour	Matte Zinc and Aqua	Matte Granite with Silver	Matte Bone with Silver Decals	Matte Granite with Bone and Silver Decals
Sizes Available	S, M, L	S, M, L	S, M, L	S, M, L
Frame	6061 Hydro Formed T6 Aluminium, Custom Drawn, Multi Butted with Custom Whyte Dropouts	6061 Hydro Formed T6 Aluminium, Custom Drawn, Multi Butted with Custom Whyte Dropouts	6061 Hydro Formed T6 Aluminium, Custom Drawn, Multi Butted with Custom Whyte Dropouts	6061 Hydro Formed T6 Aluminium, Custom Drawn, Multi Butted with Custom Whyte Dropouts
Fork	SR Suntour NCX-D LO Lite, 63mm travel, Air Spring, Hydro Lockout and Alloy Steerer tube	SR Suntour NVX HLO Lite, 63mm travel, Hydro Lockout	SR Suntour NCX-D LO Lite, 63mm travel, Air Spring, Hydro Lockout and Alloy steerer tube	SR Suntour NVX MLO Lite, 63mm travel with Lockout
Rear Shock	N/A	N/A	N/A	N/A
Headset	FSA Semi Integrated, 1 1/8" Sealed Cartridge Bearings	FSA Semi Integrated, 1 1/8" Sealed Cartridge Bearings	FSA Semi Integrated, 1 1/8" Sealed Cartridge Bearings	FSA Semi Integrated, 1 1/8" Sealed Cartridge Bearings
Rear Hub	Alloy, Double Sealed Bearings, 32 Hole	Alloy, Double Sealed Bearing, 32 Hole	Alloy, Double Sealed Bearing, 32 Hole	Alloy, Double Sealed Bearing, 32 Hole
Front Hub	Alloy, Double Sealed Bearings, 32 Hole	Alloy, Double Sealed Bearing, 32 Hole	Alloy, Double Sealed Bearing, 32 Hole	Alloy, Double Sealed Bearing, 32 Hole
Spokes	WTB 15g, Black Stainless with Brass Nipples	WTB 15g, Silver Stainless with Brass Nipples	WTB 15g, Black Stainless with Brass Nipples	WTB 15g, Silver Stainless with Brass Nipples
Rims	WTB SX-17 700c, 32 Hole, with eyelets	WTB SX-17 700c, 32 Hole, with eyelets	WTB SX-17 700c, 32 Hole, with eyelets	WTB SX-17 700c, 32 Hole, with eyelets
Tyres	WTB All Terrain Comp 700 x 35c, with Flat Guard	WTB All Terrain Comp 700 x 35c with Flat Guard	WTB All Terrain Comp 700 x 35c, Folding with Flat Guard	WTB All Terrain Comp 700 x 35c with Flat Guard
Shift Levers	Shimano Alivio, 9 Speed	Shimano Acera, 9 Speed	Shimano Alivio, 9 Speed	Shimano Acera, 9 Speed
Front Derailleur	Shimano Acera, 9 Speed	Shimano Acera, 9 Speed	Shimano Acera, 9 Speed	Shimano Acera, 9 Speed
Rear Derailleur	Shimano SLX Shadow	Shimano Alivio, 9 Speed	Shimano Deore Shadow	Shimano Alivio, 9 Speed
Cassette	Shimano Alivio HG-30, 11-32, 9 Speed	Shimano HG-20, 11-32, 9 Speed	Shimano CS-HG-30, 11-32, 9 Speed	Shimano CS-HG-20, 11-32, 9 Speed
Chain	Shimano HG-53, 9 Speed	Shimano HG-53, 9 Speed	Shimano HG-53, 9 Speed	Shimano HG-53, 9 Speed
Crankset	Shimano Deore M431, 48-36-26, Octalink	Shimano M391 Acera, 48-36-26	Shimano Deore M431, 48-36-26, Octalink	Shimano M391 Acera, 48-36-26
Bottom Bracket	Shimano ES-25 Octalink	Square Taper	Shimano ES-25 Octalink	Square Taper
Seatpost	Whyte 20mm Offset, 30.9mm x 400mm, 6061 Alloy, 2 bolt clamp	Whyte 20mm Offset, 30.9mm x 400mm, 6061 Alloy, With 2 Bolt Clamp	Whyte 20mm Offset, 30.9mm x 400mm, 6061 Alloy, 2 bolt clamp	Whyte 20mm Offset, 30.9mm x 400mm, 6061 Alloy, 2 bolt clamp
Seat	Whyte Custom, triple panel design	Whyte Custom, triple panel design	Whyte Custom Women's Fit, triple panel design With Snake Skin effect	Whyte Custom Women's Fit, triple panel design With Snake Skin effect
Bar	Whyte High Rise 30mm, 31.8mm, 620mm Wide	Whyte High Rise 30mm, 31.8mm, 620mm Wide	Whyte High Rise 30mm, 31.8mm, 620mm Wide	Whyte High Rise 30mm, 31.8mm, 620mm Wide
Stem	Whyte Custom, 70mm S, 80mm M, 90mm L	Whyte Custom, 70mm S, 80mm M, 90mm L	Whyte Custom, 70mm S, 80mm M, 90mm L	Whyte Custom, 70mm S, 80mm M, 90mm L
Grips	Whyte Custom Ergo Dual Density Lock-on's	Whyte Custom Ergo Dual Density Lock-on's	Whyte Custom Ergo Dual Density Lock-on's	Whyte Custom Ergo Dual Density Lock-on's
Front Brake	Shimano M446, 160mm Rotor	Tektro HDC 300, 160mm Rotor	Tektro Draco 2, 160mm Rotor	Tektro HDC 300, 160mm Rotor
Rear Brake	Shimano M446, 160mm Rotor	Tektro HDC 300, 160mm Rotor	Tektro Draco 2, 160mm Rotor	Tektro HDC 300, 160mm Rotor
Brake Levers	Shimano M446	Tektro HDC 300	Tektro Draco 2	Tektro HDC 300
Pedals	VP Composite with Alloy Cage and Toe Clip	VP Composite with Toe Clip	VP Composite with Alloy Cage and Toe Clip	VP Composite with Toe Clip

Specification details were correct at the time of printing. However, product changes may occur after this time.
Please check model availability and full specification details with your dealer prior to ordering.

CROSS			
Model	Whyte Saxon Cross	Whyte Charing Cross	Whyte Kings Cross
Colour	Matt Granite with Apple and White Decals	Granite Black Matt with Grey Decals	Granite Matt with White and Aqua Decals
Sizes Available	51cm, 53cm, 55cm, 57cm	51cm, 53cm, 55cm, 57cm, 59cm	51cm, 53cm, 55cm, 57cm, 59cm
Frame	6061 Hydro Formed T6 Aluminium, Custom Drawn, Multi Butted with Post Mount Disk mount	6061 Hydro Formed T6 Aluminium, Custom Drawn, Multi Butted with Post Mount Disk mount	6061 Hydro Formed T6 Aluminium, Custom Drawn, Multi Butted with Post Mount Disk mount
Fork	Straight Bladed Full Carbon Front Fork with Tapered Alloy Steerer, with Post Mount Dropouts	Straight Bladed Carbon Front Fork, with Eyelets, Post Mount disk mount, Tapered Steerer	Straight Bladed Alloy Front Fork, with Eyelets, Post Mount disk mount, Tapered Steerer
Rear Shock	N/A	N/A	N/A
Headset	FSA Integrated Road, 1 1/2" lower and 1 1/8" upper Sealed Cartridge Bearings	FSA Integrated Road, 1 1/2" lower and 1 1/8" upper Sealed Cartridge Bearings	FSA Integrated Road, 1 1/2" lower Sealed Cartridge Bearing and 1 1/8" upper Sealed Ball Retainer
Rear Hub	Whyte Alloy Double Sealed with Cartridge Bearings, 32 Hole	Whyte Alloy, 32 Hole	Whyte Alloy, Double Sealed Bearings, 32 Hole
Front Hub	Whyte Alloy Double Sealed with Cartridge Bearings, 28 Hole	Whyte Alloy, 28 Hole	Whyte Alloy, Double Sealed Bearings, 28 Hole
Spokes	DT Champion Black SIST	WTB 15g, Black Stainless with Brass Nipples	WTB PG 15g, Black Sandvik Stainless with Black Brass Nipples
Rims	WTB Custom Frequency Team i19 TCS, Tubeless Ready, Disk Specific, 28/32 Hole	Alex Black Dragon 24, Deep Section, Disk Specific Road, 32 Hole Rear and 28 Front	Alex Black Dragon 24, Deep Section, Disk Specific Road, 32 Hole Rear and 28 Front
Tyres	Maxxis Raze CX Tyre, 700 x 33c, Black	Maxxis Detonator, 700 x 28c, Black/Grey, with Puncture Protection, Folding	Maxxis Detonator, 700 x 28c, Black, with Puncture Protection
Shift Levers	SRAM Apex 10 Speed	Shimano ST-4600 Tiagra, 10 Speed	Shimano ST-3500 SORA, 9 Speed
Front Derailleur	SRAM Apex, 10 Speed	Shimano FD-4600 Tiagra, 10 Speed	Shimano FD-3500 SORA, 9 Speed
Rear Derailleur	SRAM Rival, 10 Speed	Shimano RD-4600 Tiagra, 10 Speed	Shimano RD-3500 SORA, 9 Speed
Cassette	SRAM PG-1050, 11-28, 10 Speed	Shimano CS-4600 11-30, 10 Speed	SRAM PG-950, 11-32, 9 Speed
Chain	SRAM PC-1031	Shimano CN-4601 Tiagra, 10 Speed	Shimano HG53, 9 Speed
Crankset	FSA Gossamer Pro Cross PF-386, 36-46, 10 Speed, Compact Double	FSA Gossamer 34-50, 10 Speed, Compact Double	FSA Vero, 34-50, 9 Speed, Compact Double
Bottom Bracket	FSA PF-386	FSA Mega Exo	FSA Square Taper
Seatpost	Whyte 20mm Offset, 27.2mm x 350mm, 2014 Alloy, 2 Bolt Clamp	Whyte 20mm Offset, 27.2mm x 350mm, 2014 Alloy, 2 Bolt Clamp	Whyte 20mm Offset, 27.2mm x 350mm, 2014 Alloy, 2 Bolt Clamp
Seat	Whyte Custom, Light Weight Triple Density Base, Triple Panel Design	Whyte Custom, Triple Panel Design	Whyte Custom, Triple Panel Design
Bar	FSA Gossamer Ergo, 460mm Wide	Whyte Cross, 31.8mm, Compact Style Drop Bar, 440mm Wide	Whyte Cross, 31.8mm, Compact Style Drop Bar, 440mm Wide
Stem	Whyte -6 Deg, 70mm 51, 80mm 53, 90mm 55 & 57	Whyte 6 Deg, 70mm 51, 80mm 53, 90mm 55 & 57	Whyte 6 Deg, 70mm 51, 53, 80mm, 55, 90mm 57
Grips	Whyte Anti Slip, Cross Bar Tapes	Whyte Anti Slip, Cross Bar Tapes	Whyte Anti Slip, Cross Bar Tapes
Front Brake	AVID BB-7 Mech, 160mm Rotor	AVID BB-5 Mech, 160mm Rotor	Pro Max CX Mechanical Discs, 160mm Rotor
Rear Brake	AVID BB-7 Mech, 160mm Rotor	AVID BB-5 Mech, 160mm Rotor	Pro Max CX Mechanical Discs, 160mm Rotor
Brake Levers	SRAM Apex	Shimano ST-4600	Shimano ST-3500 SORA
Pedals	None	Full Alloy with Toe Clip	Composite with Alloy Cage and Toe Clip

Specification details were correct at the time of printing. However, product changes may occur after this time.
Please check model availability and full specification details with your dealer prior to ordering.

R7 FAST URBAN				
Model	Whyte Montpellier	Whyte Stirling	Whyte Cambridge	Whyte Cambridge Varsity
Colour	Matt Black UD with stealth grey graphics	Granite Black Mat with Orange Decals	Matt Dark Grey with Aqua Decals	Matt Aqua with Grey Decals
Sizes Available	M, L, XL	S, M, L, XL	S, M, L, XL	S, M, L, XL
Frame	Full Carbon Monocoque with tapered headtube and internal cable routing	6061 Hydro Formed T6 Aluminium, Custom Drawn, Multi Butted with Custom Whyte Dropouts	6061 Hydro Formed T6 Aluminium, Custom Drawn, Multi Butted with Custom Whyte Dropouts	6061 Hydro Formed T6 Aluminium, Custom Drawn, Multi Butted with Custom Whyte Dropouts
Fork	Straight Bladed Carbon Front Fork with Alloy steerer tube and single eyelets	Straight Bladed Carbon Front Fork with Alloy steerer tube and single eyelets	Straight Bladed Carbon Front Fork, with Alloy steerer tube and single eyelets	Straight Bladed Carbon Front Fork, with Alloy steerer tube and single eyelets
Rear Shock	N/A	N/A	N/A	N/A
Headset	FSA Integrated Road, 1 1/8" upper Sealed Cartridge Bearing, 1.5 lower Sealed Cartridge Bearing	FSA No 23 Integrated Road, 1 1/8" Sealed Cartridge Bearings, 41mm Diameter	FSA No 23 Integrated Road, 1 1/8" Sealed Cartridge Bearings, 41mm Diameter	FSA No 23 Integrated Road, 1 1/8" Sealed Cartridge Bearings, 41mm Diameter
Rear Hub	Hope EVO, with Stainless Steel bearings, 32 Hole	Alloy, Double Sealed Hub, 32 Hole	Alloy, Double Sealed Bearing Hub, 32 Hole	Alloy, Double Sealed Bearing Hub, 32 Hole
Front Hub	Hope EVO, with Stainless Steel bearings, 28 Hole	Alloy, Double Sealed Cartridge Bearing Hub, 28 Hole	Alloy, Double Sealed Bearing Hub, 28 Hole	Alloy, Double Sealed Bearing Hub, 28 Hole
Spokes	DT Champion, 15g Black Stainless with Brass Nipples	DT Champion, 14g Black Stainless with Brass Nipples	WTB PG 15g, Black Stainless with Brass Nipples	WTB PG 15g, Black Stainless with Brass Nipples
Rims	Alex Black Dragon 24, Deep Section, Disk Specific Road, 32 Hole Rear and 28 Front	Alex Black Dragon 24, Deep Section, Disk Specific Road, 32 Hole Rear and 28 Front	Alex Black Dragon 24, Deep Section, Disk Specific Road, 32 Hole Rear and 28 Front	Alex Black Dragon 24, Deep Section, Disk Specific Road, 32 Hole Rear and 28 Front
Tyres	Maxxis Detonator, 700 x 28c, Grey, Folding with Puncture Protection	Maxxis Detonator, 700 x 28c, Grey, Folding with Puncture Protection	Maxxis Detonator, 700 x 28c, Grey, Folding with Puncture Protection	Maxxis Detonator, 700 x 28c, Grey, Folding with Puncture Protection
Shift Levers	SRAM Via GT, Matchmaker, 10 Speed	SRAM Via GT, 10 Speed	SRAM X-5, 10 Speed	SRAM X-5, 10 Speed
Front Derailleur	SRAM Via GT	SRAM Via Centro, 10 Speed	SRAM VIA, 10 Speed	SRAM VIA, 10 Speed
Rear Derailleur	SRAM Via GT 10 Speed	SRAM Via GT, 10 Speed	SRAM APEX, 10 Speed	SRAM APEX, 10 Speed
Cassette	SRAM PG-1050, 11-32, 10 Speed	SRAM PG-1030, 11-32, 10 Speed	SRAM APEX PG-1050, 11-32, 10 Speed	SRAM APEX PG-1050, 11-32, 10 Speed
Chain	SRAM PC-1031, 10 Speed	SRAM PC-1031, 10 Speed	SRAM PC-1030, 10 Speed	SRAM PC-1030, 10 Speed
Crankset	SRAM Via GT, 48-32 Urban Compact, 10 Speed	SRAM Via GT, 48-32 Urban Compact, 10 Speed	SRAM Via Centro, 48-32, 10 Speed, Compact	SRAM Via Centro, 48-32, 10 Speed, Compact
Bottom Bracket	SRAM GXP	SRAM GXP	SRAM Power Spline, 68mm Shell	SRAM Power Spline, 68mm Shell
Seatpost	Whyte 20mm Offset, 27.2mm x 350mm, 2014 Alloy, 2 Bolt Clamp	Whyte 20mm Offset, 27.2mm x 350mm, 2014 Alloy, 2 Bolt Clamp	Whyte 20mm Offset, 27.2mm x 350mm, 2014 Alloy, 2 Bolt Clamp	Whyte 20mm Offset, 27.2mm x 350mm, 2014 Alloy, 2 Bolt Clamp
Seat	SR Viper, with Scuff Guards, Snake Skin Cover	Whyte Custom, Triple Panel Design, Black Snake Skin Cover	Whyte Custom, Triple Panel Design, Dark Brown Snake Skin Cover	Whyte Custom, Triple Panel Design, Black Snake Skin Cover
Bar	Whyte Narrow, 31.8mm, Flat Bar, 580mm Wide	Whyte Narrow, 31.8mm, 20mm Rise, 580mm Wide	Whyte Narrow, 31.8mm, 20mm Rise, 580mm Wide	Whyte Narrow, 31.8mm, 20mm Rise, 580mm Wide
Stem	Whyte, 80mm M, 90mm L & XL	Whyte, 70mm S, 80mm M, 90mm L & XL	Whyte, 70mm S, 80mm M, 90mm L & XL	Whyte, 70mm S, 80mm M, 90mm L & XL
Grips	GP1 Ergon Grip, Dual Density	GP1 Ergon Grip, Dual Density	Whyte Custom Dual Density. Lock-on	Whyte Custom Dual Density. Lock-on
Front Brake	SRAM Via GT, 160mm Rotor	Avid Elixir 1, 160mm Rotor	Tektro Draco 2, 160mm Rotor	Tektro Draco 2, 160mm Rotor
Rear Brake	SRAM Via GT, 160mm Rotor	Avid Elixir 1, 160mm Rotor	Tektro Draco 2, 160mm Rotor	Tektro Draco 2, 160mm Rotor
Brake Levers	SRAM Via GT, Matchmaker	Avid Elixir 1	Tektro Draco 2	Tektro Draco 2
Pedals	None	Full Alloy with Toe Clip	Composite with Alloy Cage and Toe Clip	Composite with Alloy Cage and Toe Clip

Specification details were correct at the time of printing. However, product changes may occur after this time. Please check model availability and full specification details with your dealer prior to ordering.

	R7 FAST URBAN	R7 FAST URBAN WOMEN'S
Model	Whyte Portobello	Whyte Victoria
Colour	Granite Black Matt with Apple Green	Granite Black Matt with Aqua
Sizes Available	S, M, L, XL	XS, S, M
Frame	6061 Hydro Formed T6 Aluminium, Custom Drawn, Multi Butted with Custom Whyte Dropouts	6061 Hydro Formed T6 Aluminium, Custom Drawn, Multi Butted with Custom Whyte Dropouts
Fork	Straight Bladed 6061 Alloy T6 Front Fork, with Single Eyelets	Straight Bladed 6061 Alloy T6 Front Fork, with Single Eyelets
Rear Shock	N/A	N/A
Headset	FSA Integrated Road, 1 1/8" Sealed Cartridge Bearings, 41mm Diameter	FSA Integrated Road, 1 1/8" Sealed Cartridge Bearings, 41mm Diameter
Rear Hub	Alloy, Double Sealed Bearing Hub, 32 Hole	Alloy, Double Sealed Bearing Hub, 32 Hole
Front Hub	Alloy, Double Sealed Bearing Hub, 28 Hole	Alloy, Double Sealed Bearing Hub, 28 Hole
Spokes	WTB PG 15g, Black Stainless with Brass Nipples	WTB PG 15g, Black Stainless with Brass Nipples
Rims	Alex Black Dragon 24, Deep Section, Disk Specific Road, 32 Hole Rear and 28 Front	Alex Black Dragon 24, Deep Section, Disk Specific Road, 32 Hole Rear and 28 Front
Tyres	Maxxis Detonator, 700 x 28c, Black, with Puncture Protection	Maxxis Detonator, 700 x 28c, Folding Black/Aqua, with Puncture Protection
Shift Levers	Shimano Sora SL-3500, 9 Speed	Shimano Sora SL-3500, 9 Speed
Front Derailleur	Shimano Sora FD-3500, 9 Speed	Shimano Sora FD-R3500, 9 Speed
Rear Derailleur	Shimano Sora RD3500, 9 Speed	Shimano Sora RD-3500, 9 Speed
Cassette	SRAM PG-950, 11-32 9 Speed	SRAM PG-950, 11-32 9 Speed
Chain	Shimano HG-53, 9 Speed	Shimano HG-53
Crankset	FSA Tempo 50-34, 9 Speed, Compact	FSA Tempo 50-34, 9 Speed, Compact, 170mm Crank arm length
Bottom Bracket	FSA Square Taper	FSA Square Taper
Seatpost	Whyte 20mm Offset, 27.2mm x 350mm, 6061 Alloy, 2 Bolt Clamp	Whyte 20mm Offset, 27.2mm x 350mm, 6061 Alloy, 2 Bolt Clamp
Seat	Whyte Custom, Triple Panel Design, Snake Skin Cover	Whyte Custom Women's Fit, Triple Panel Design with Snake Skin Cover
Bar	Whyte Narrow, 31.8mm, 20mm Rise, 580mm Wide	Whyte Narrow, 31.8mm, 20mm Rise, 580mm Wide
Stem	Whyte, 70mm S, 80mm M, 90mm L & XL	Whyte, 70mm XS & S, 80mm M
Grips	Whyte Custom Dual Density, Lock-on	Whyte double Density, Lock-on
Front Brake	Tektro HDC300, Light weight 160mm Rotor	Tektro HDC300, Light weight 160mm Rotor
Rear Brake	Tektro HDC300, Light weight 160mm Rotor	Tektro HDC300, Light weight 160mm Rotor
Brake Levers	Tektro HDC300	Tektro HDC300
Pedals	Composite with Alloy Cage and Toe Clip	Composite with Alloy Cage and Toe Clip



Specification details were correct at the time of printing. However, product changes may occur after this time. Please check model availability and full specification details with your dealer prior to ordering.



WHYTE

PERFORMANCE BY DESIGN

Specification details were correct at the time of printing. However, product changes may occur after this time.
Please check model availability and full specification details with your dealer prior to ordering.

We discourage mail order on the grounds of customer safety and ease of after-sales service.

Therefore, only bikes supplied fully assembled directly from an official dealer's premises qualify for any WHYTE warranty in the UK.
Customer's statutory rights are not affected.

www.whytebikes.co.uk